

# **Coordinate Spaces and Transformations**

---

**Interactive Computer Graphics  
Stanford CS248, Winter 2020**

# Tunes

## Kaleo

# “Way Down We Go”

(A/B)

*“And we’re using transformation matrices to get there.”*

*- JJ Julius Son*

# Cube

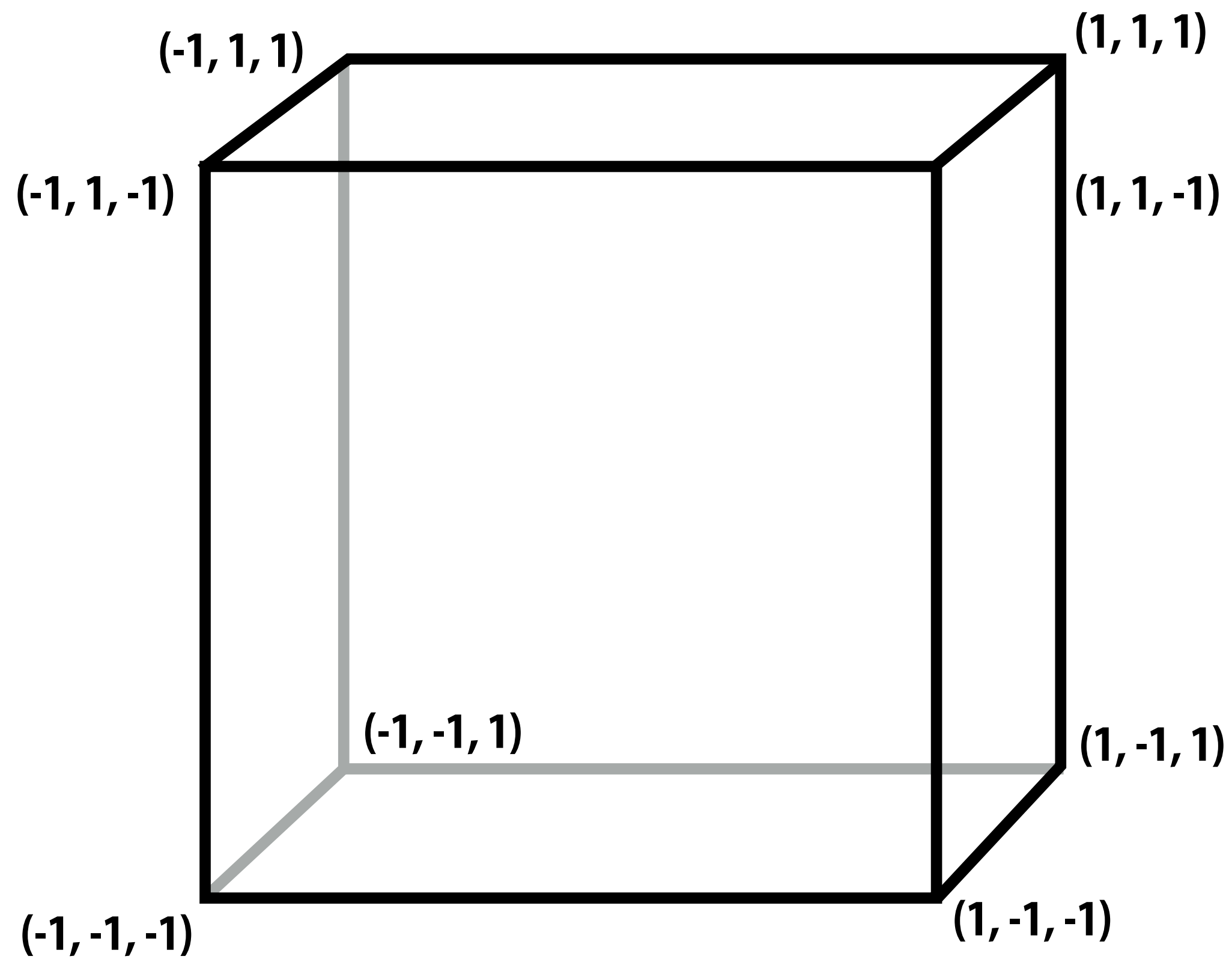

# Consider drawing a cube person

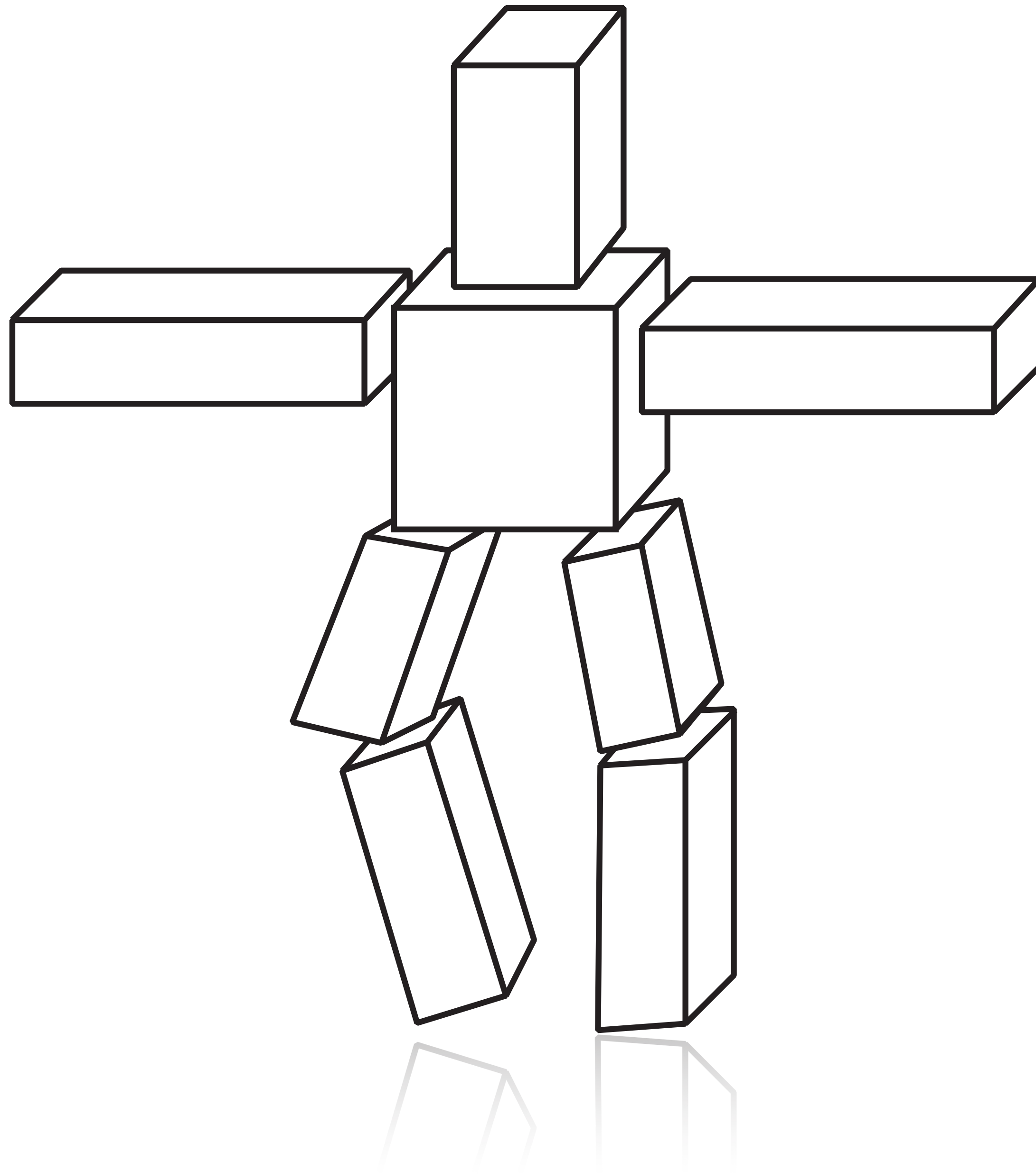



# Transformations in character rigging

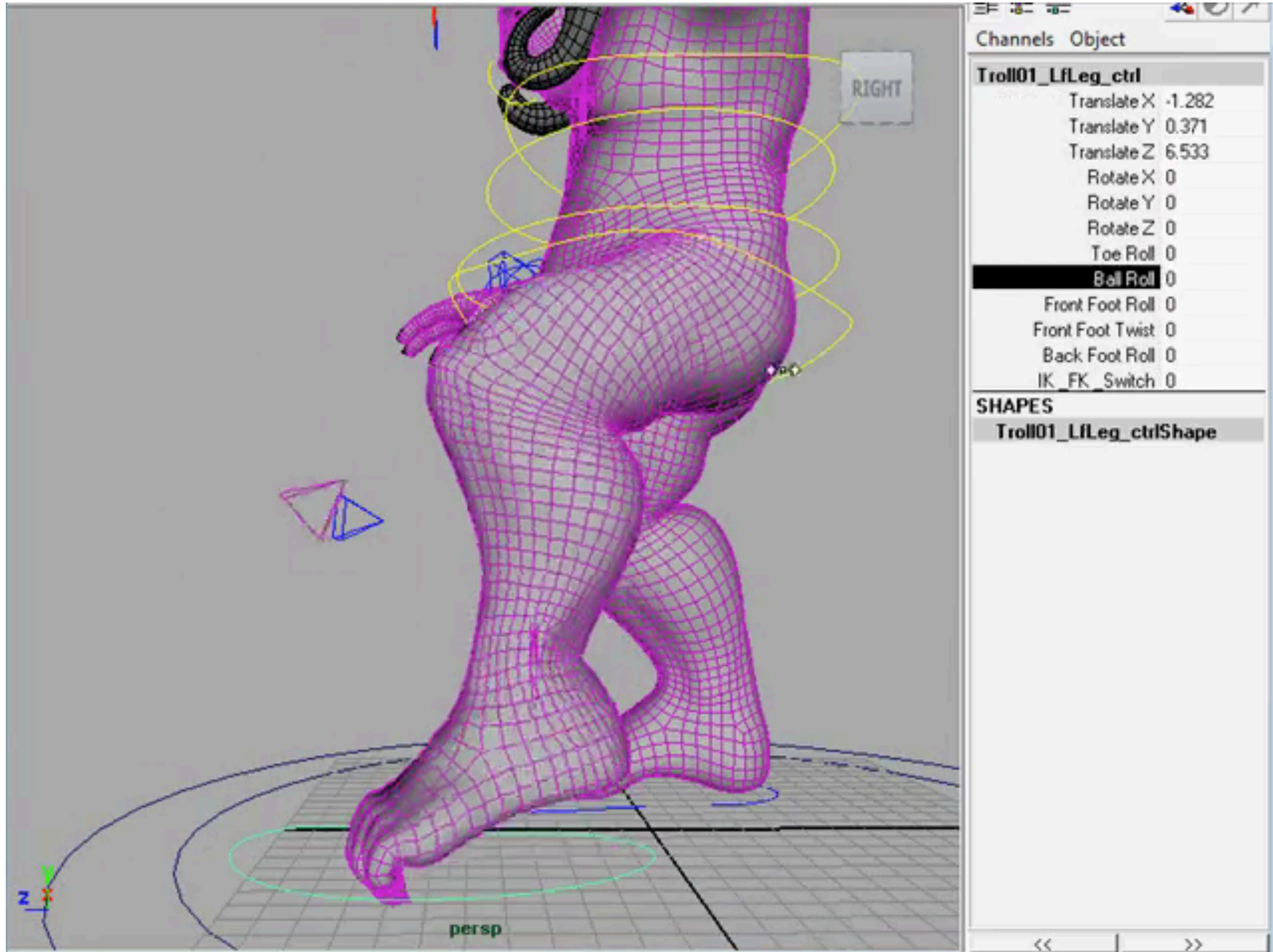



# Transformations in instancing





**Basic idea:  $f$  transforms  $\mathbf{x}$  to  $f(\mathbf{x})$**

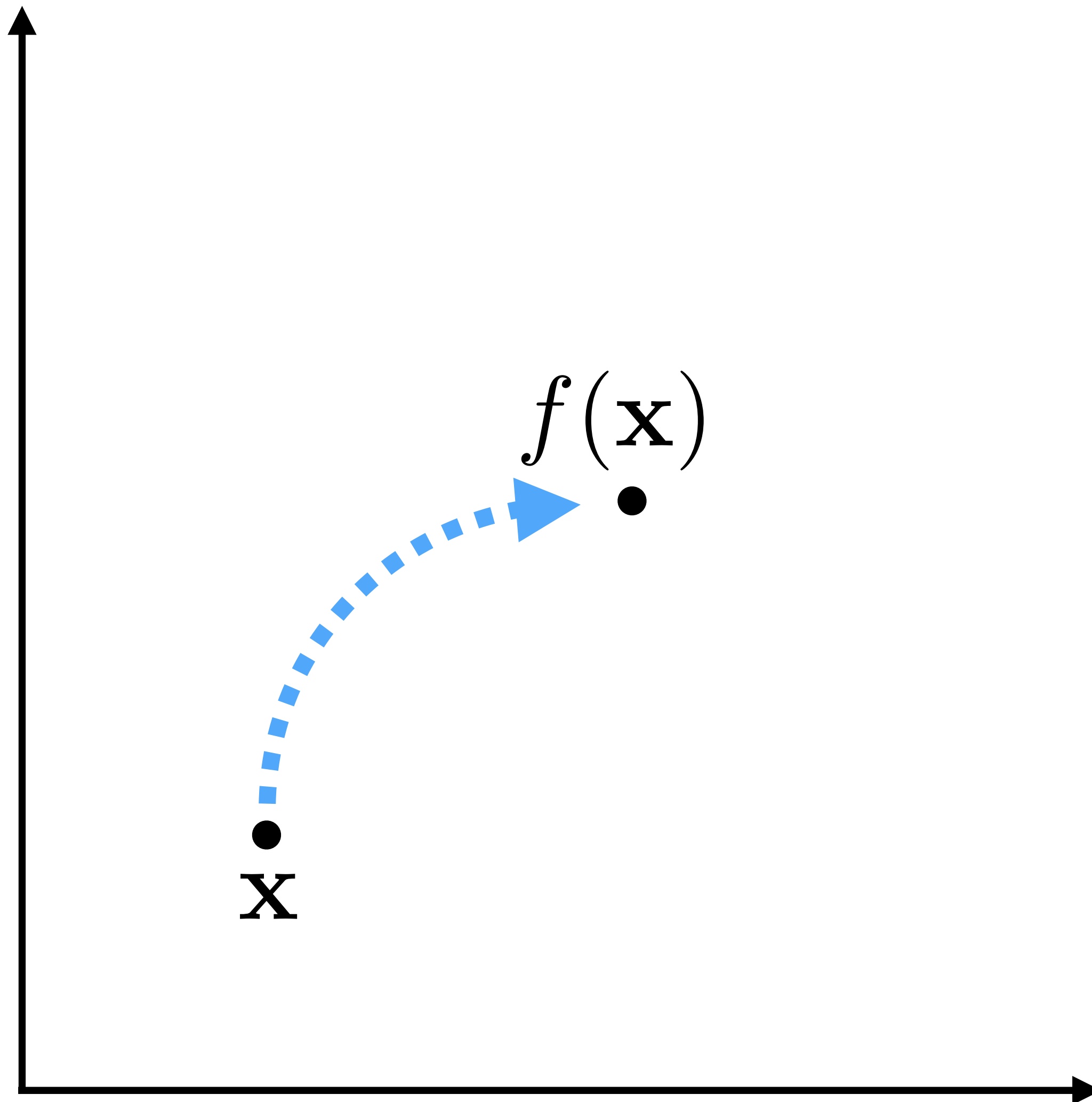

# What can we do with *linear* transformations?

- What does *linear* mean?

$$f(\mathbf{x} + \mathbf{y}) = f(\mathbf{x}) + f(\mathbf{y})$$

$$f(a\mathbf{x}) = af(\mathbf{x})$$

- Cheap to compute
- Composition of linear transformations is linear
  - Leads to uniform representation of transformations

# Linear transformation

$$f(\mathbf{u} + \mathbf{v}) = f(\mathbf{u}) + f(\mathbf{v})$$

$$f(a\mathbf{u}) = af(\mathbf{u})$$

- **In other words: if it doesn't matter whether we add the vectors and then apply the map, or apply the map and then add the vectors (and likewise for scaling):**

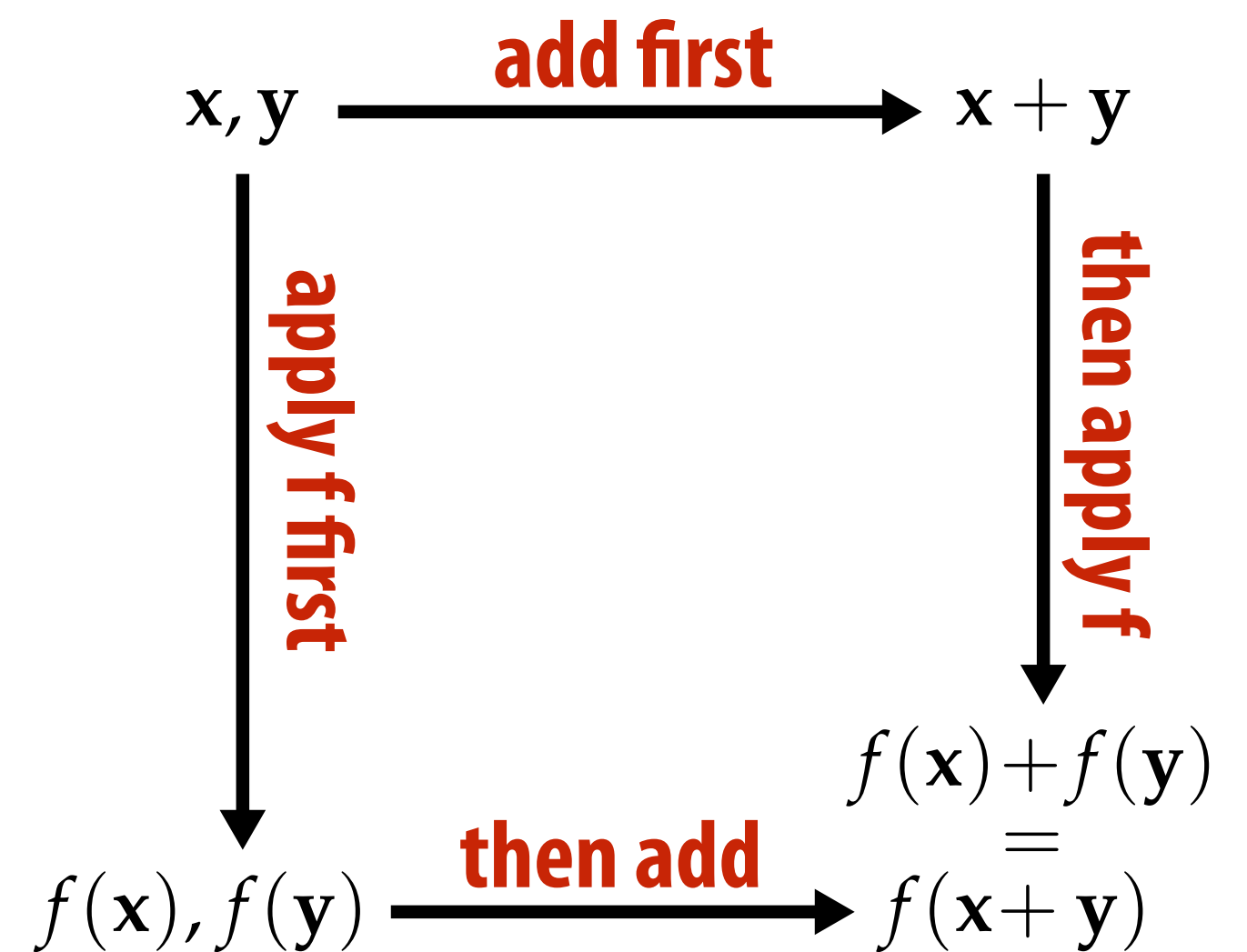

# Linear transforms/maps—visualized

## ■ Example:

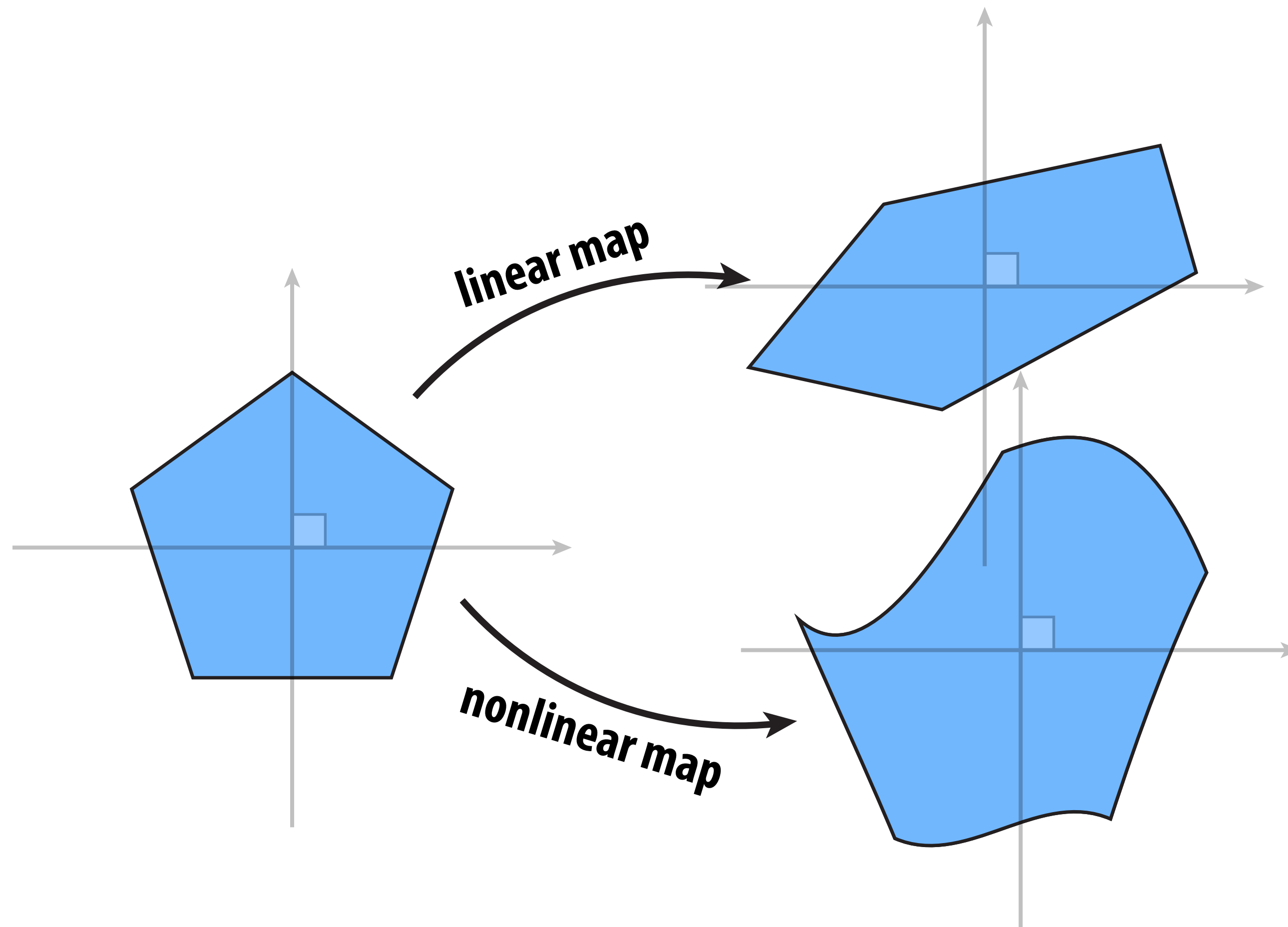

**Key idea: *linear maps take lines to lines***

# Scale

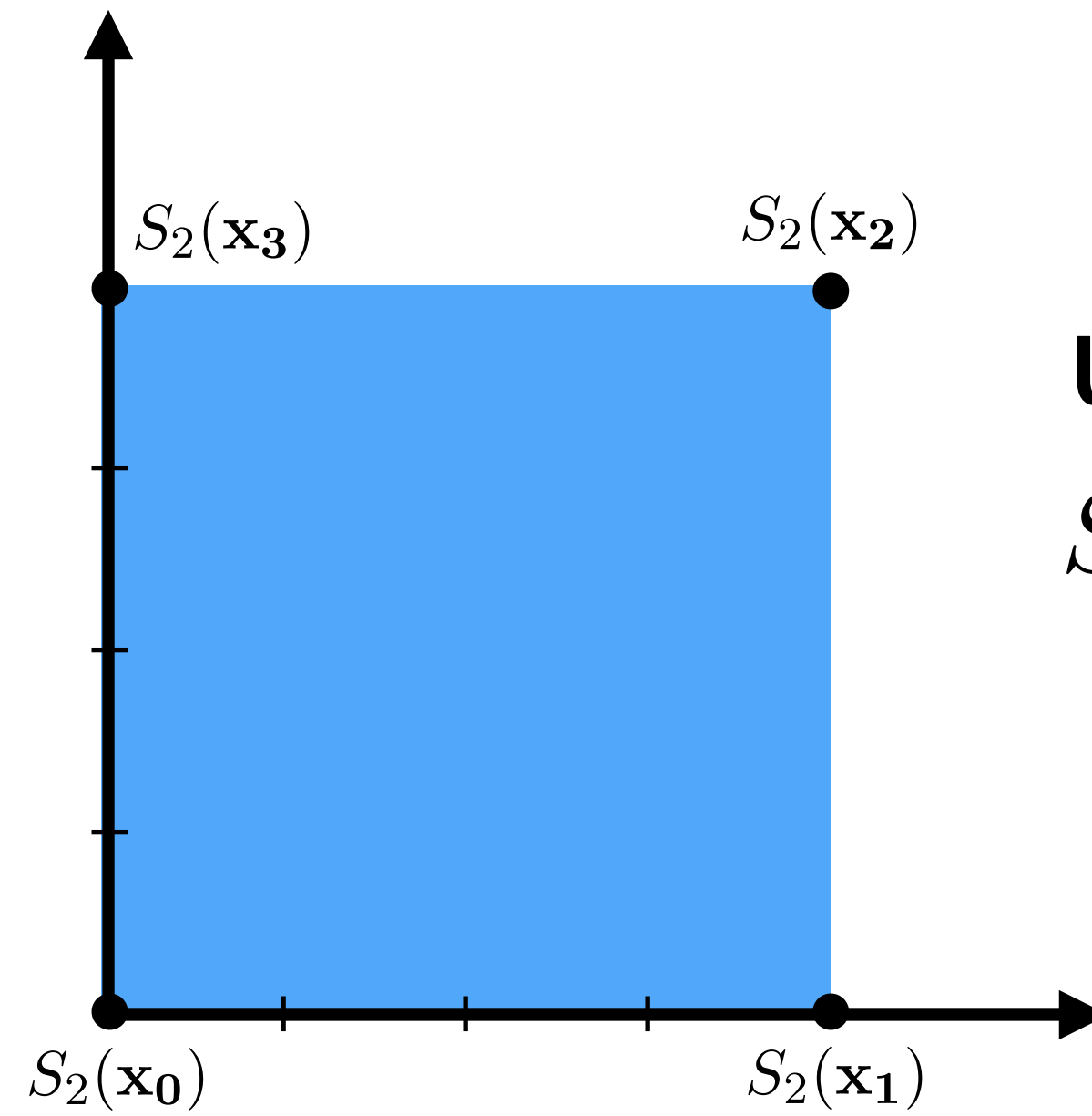
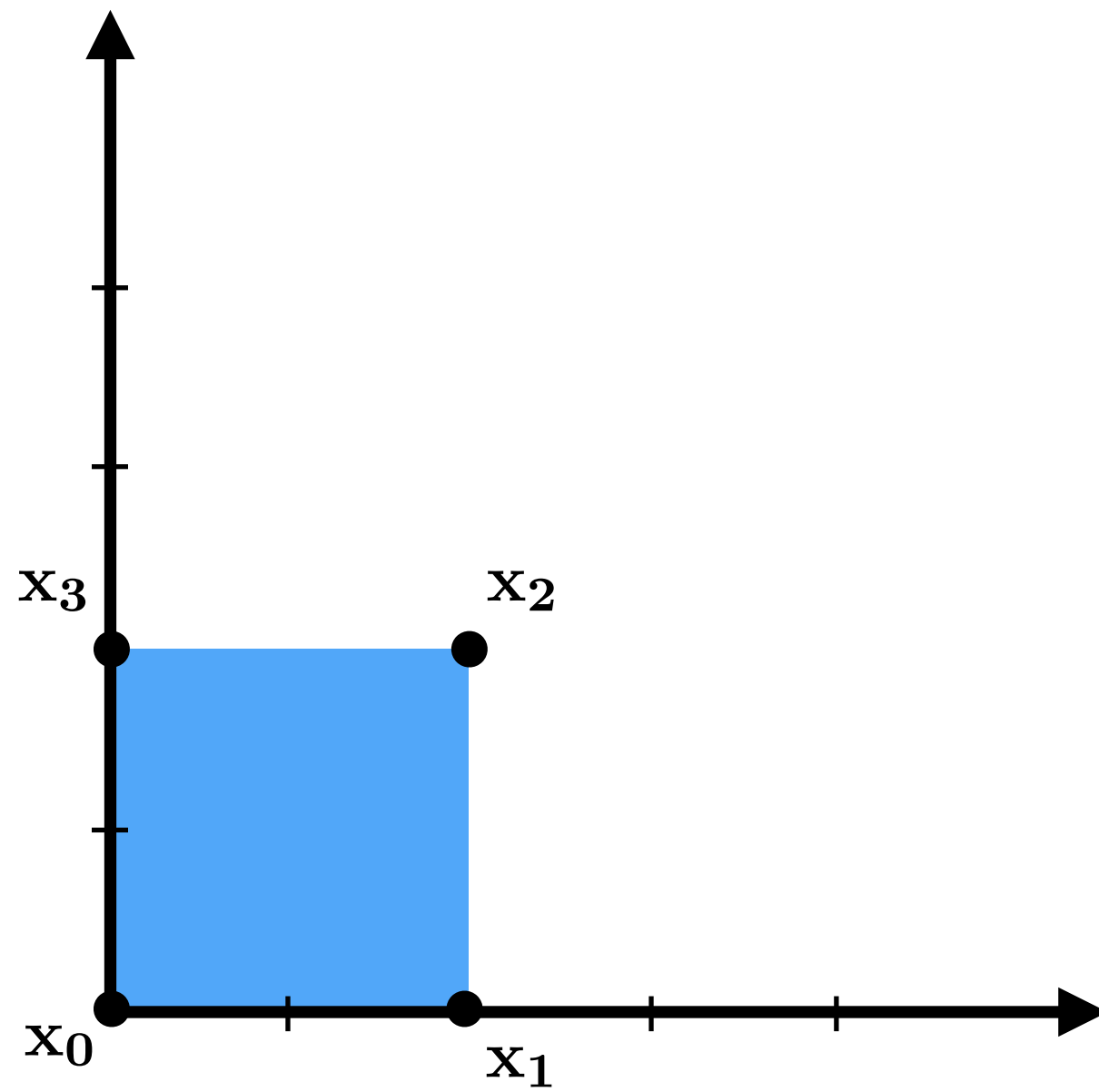

**Uniform scale:**  
 $S_a(\mathbf{x}) = a\mathbf{x}$

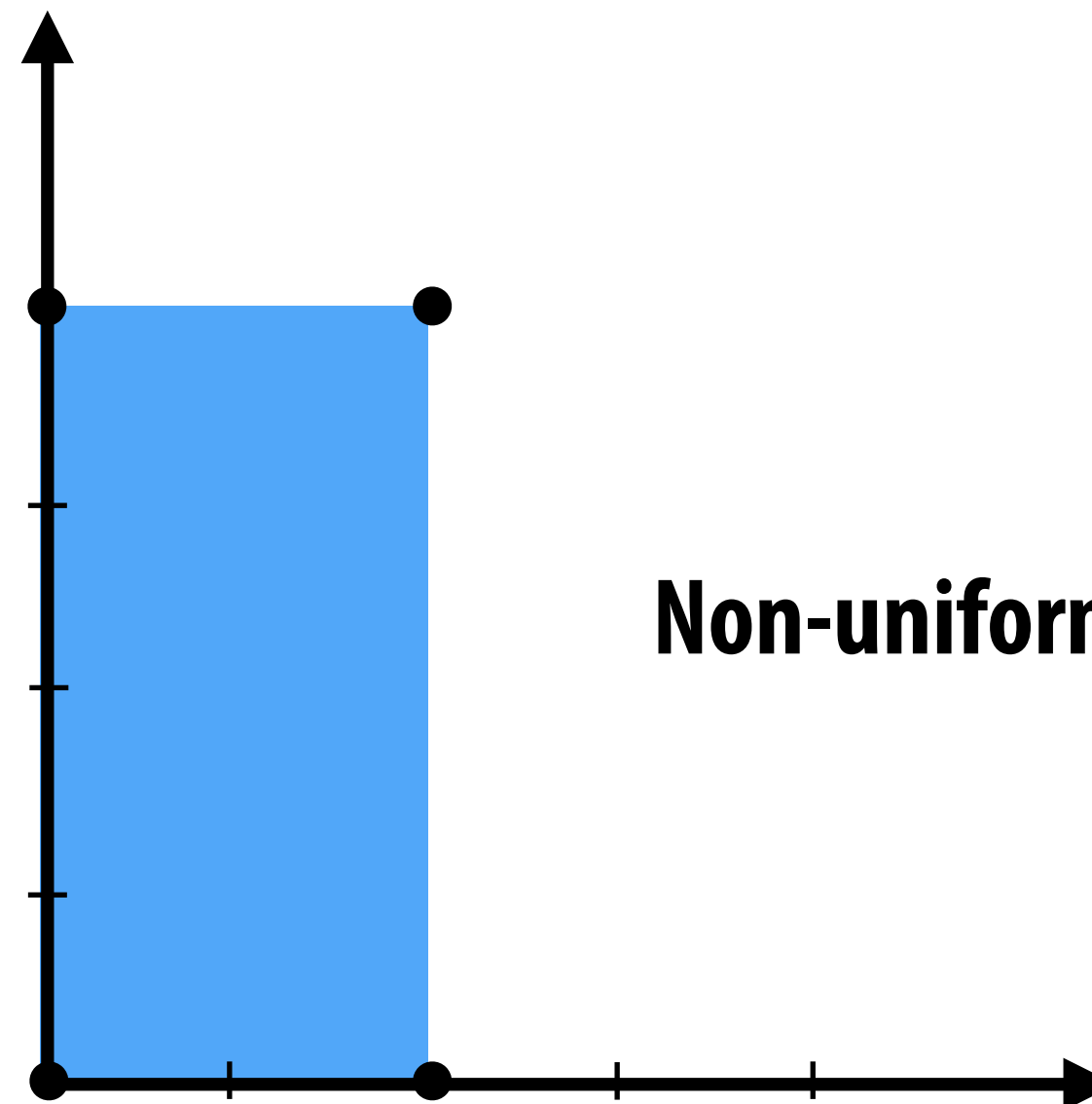

**Non-uniform scale??**

# Is scale a linear transform?

$$S_2(\mathbf{x}) = 2\mathbf{x}$$

$$aS_2(\mathbf{x}) = 2a\mathbf{x}$$

$$S_2(a\mathbf{x}) = 2a\mathbf{x}$$

$$S_2(a\mathbf{x}) = aS_2(\mathbf{x})$$

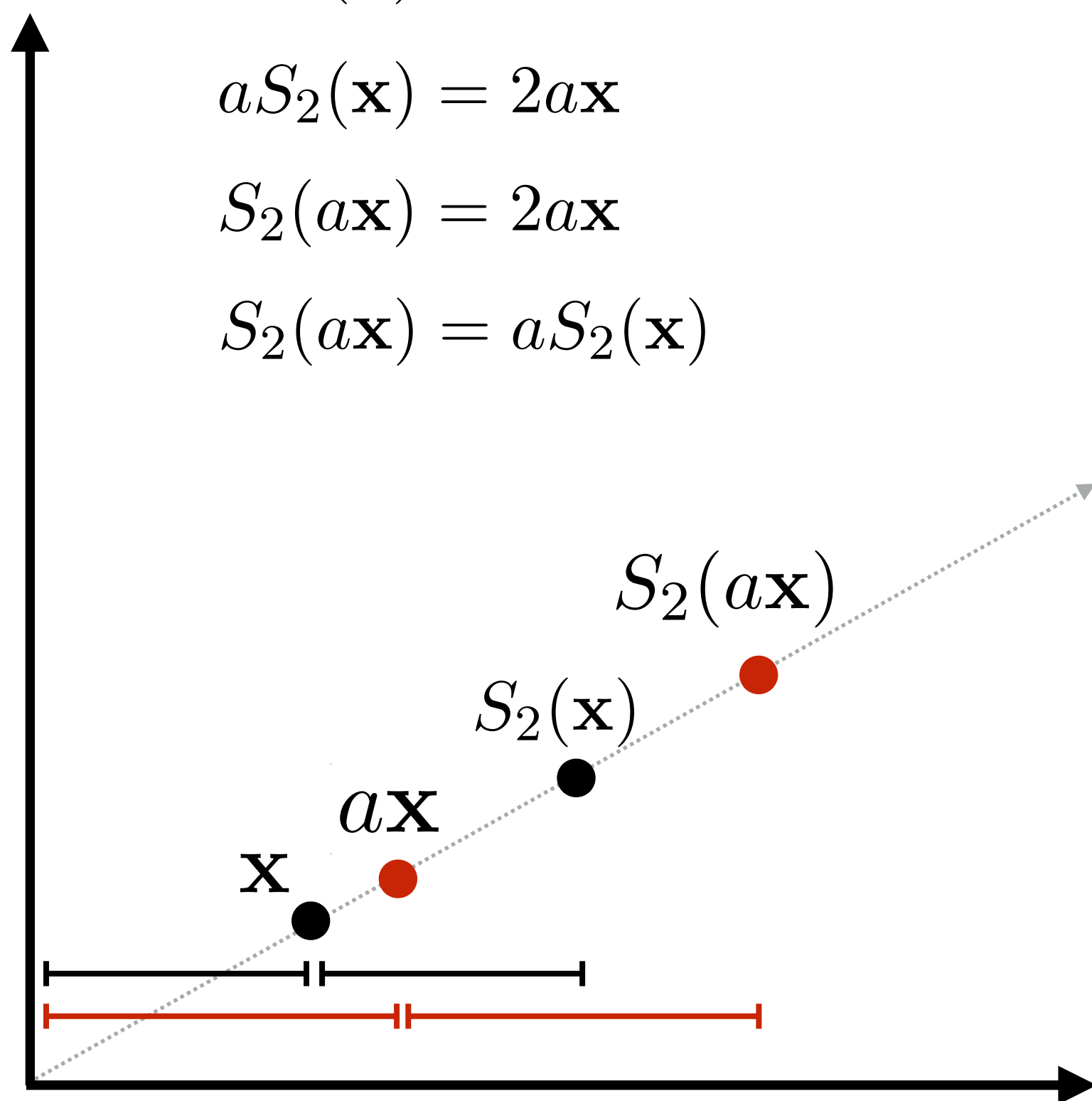

$$S_2(\mathbf{x} + \mathbf{y}) = 2(\mathbf{x} + \mathbf{y})$$

$$S_2(\mathbf{x}) + S_2(\mathbf{y}) = 2\mathbf{x} + 2\mathbf{y}$$

$$S_2(\mathbf{x} + \mathbf{y}) = S_2(\mathbf{x}) + S_2(\mathbf{y})$$

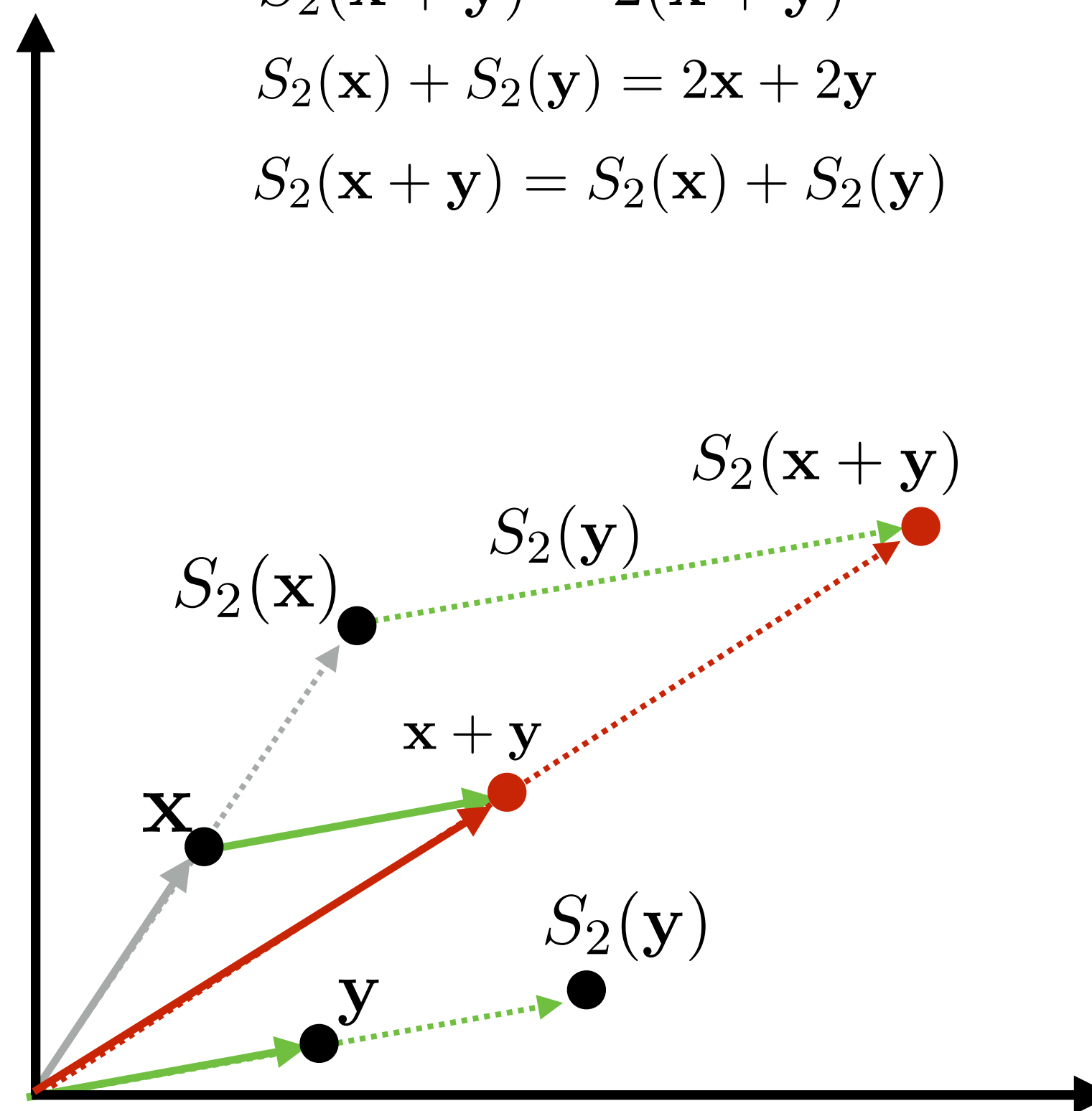

**Yes!**



# Rotation

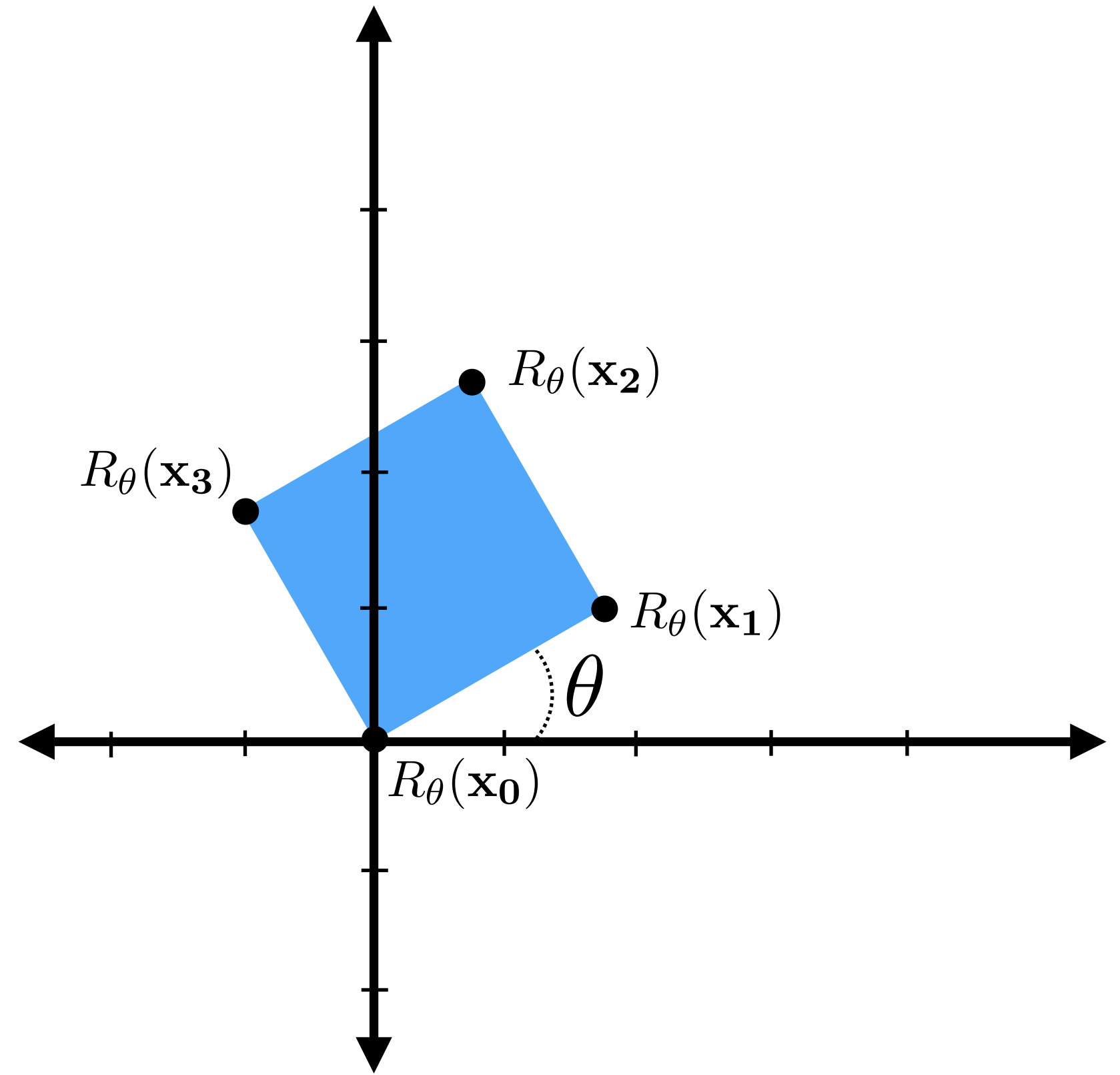
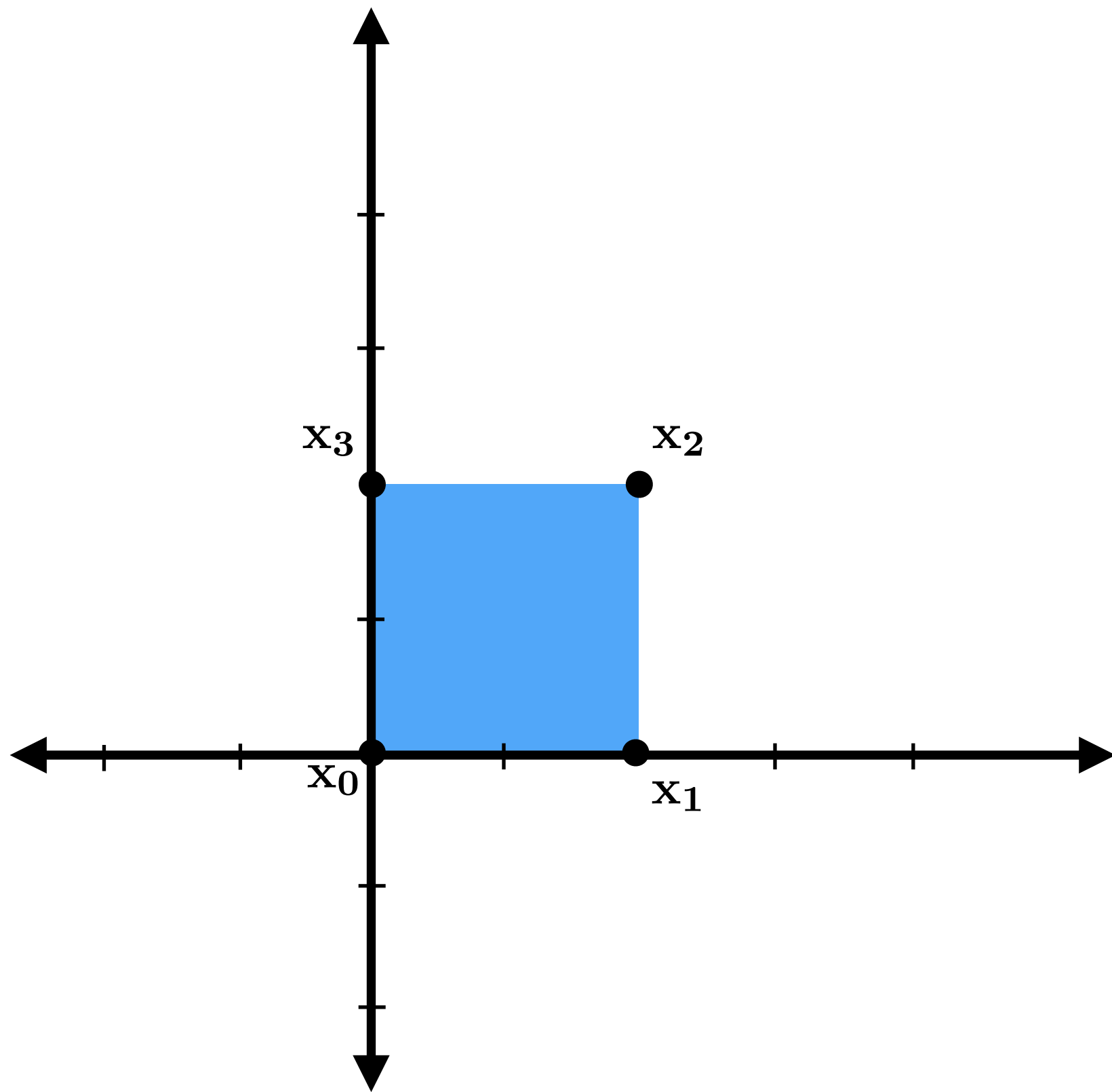

$R_\theta$  = rotate counter-clockwise by  $\theta$

# Rotation as circular motion

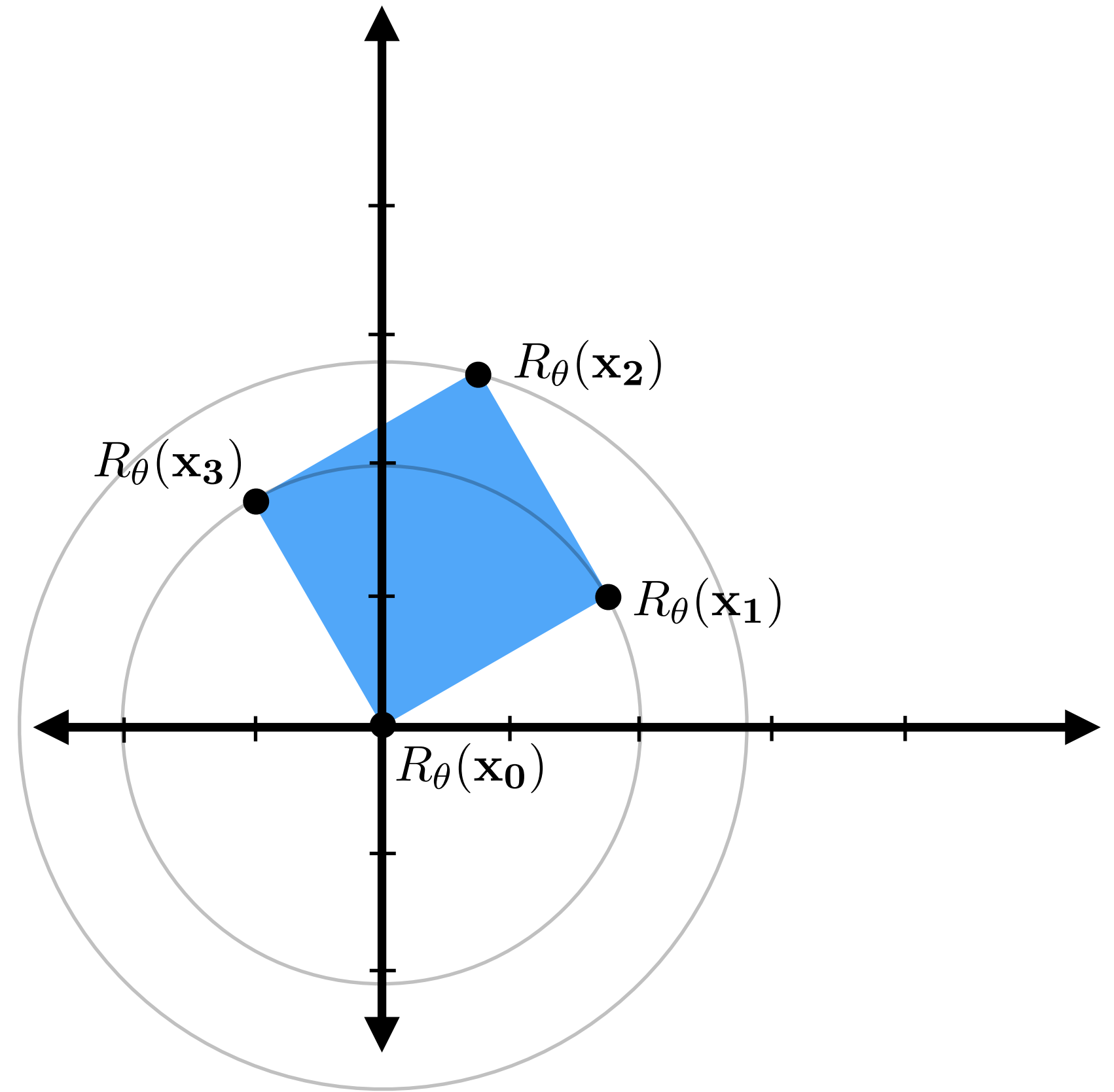
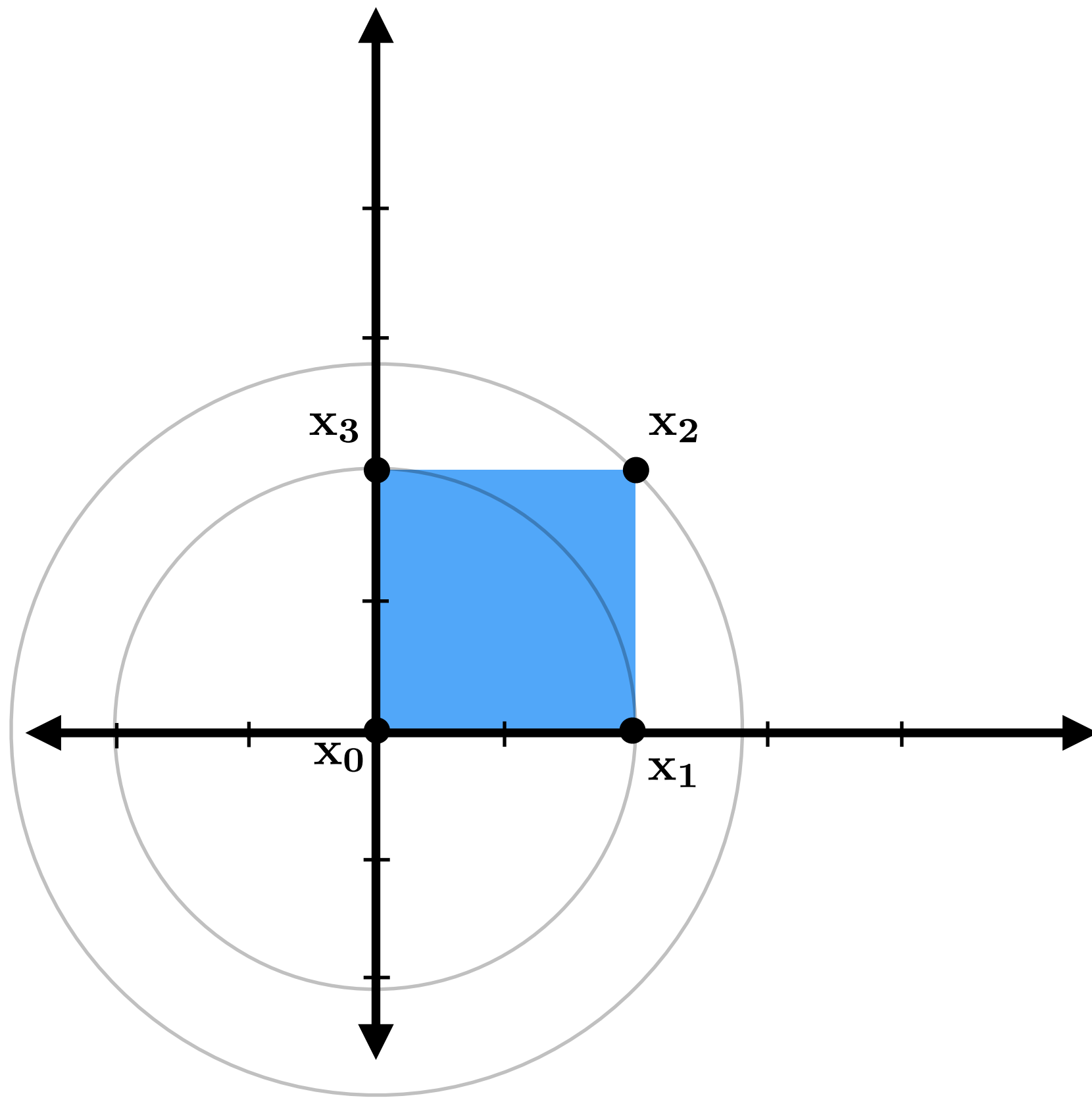

$R_\theta$  = rotate counter-clockwise by  $\theta$

As angle changes, points move along *circular* trajectories.

Hence, rotations preserve length of vectors:  $|R_\theta(\mathbf{x})| = |\mathbf{x}|$

# Is rotation linear?

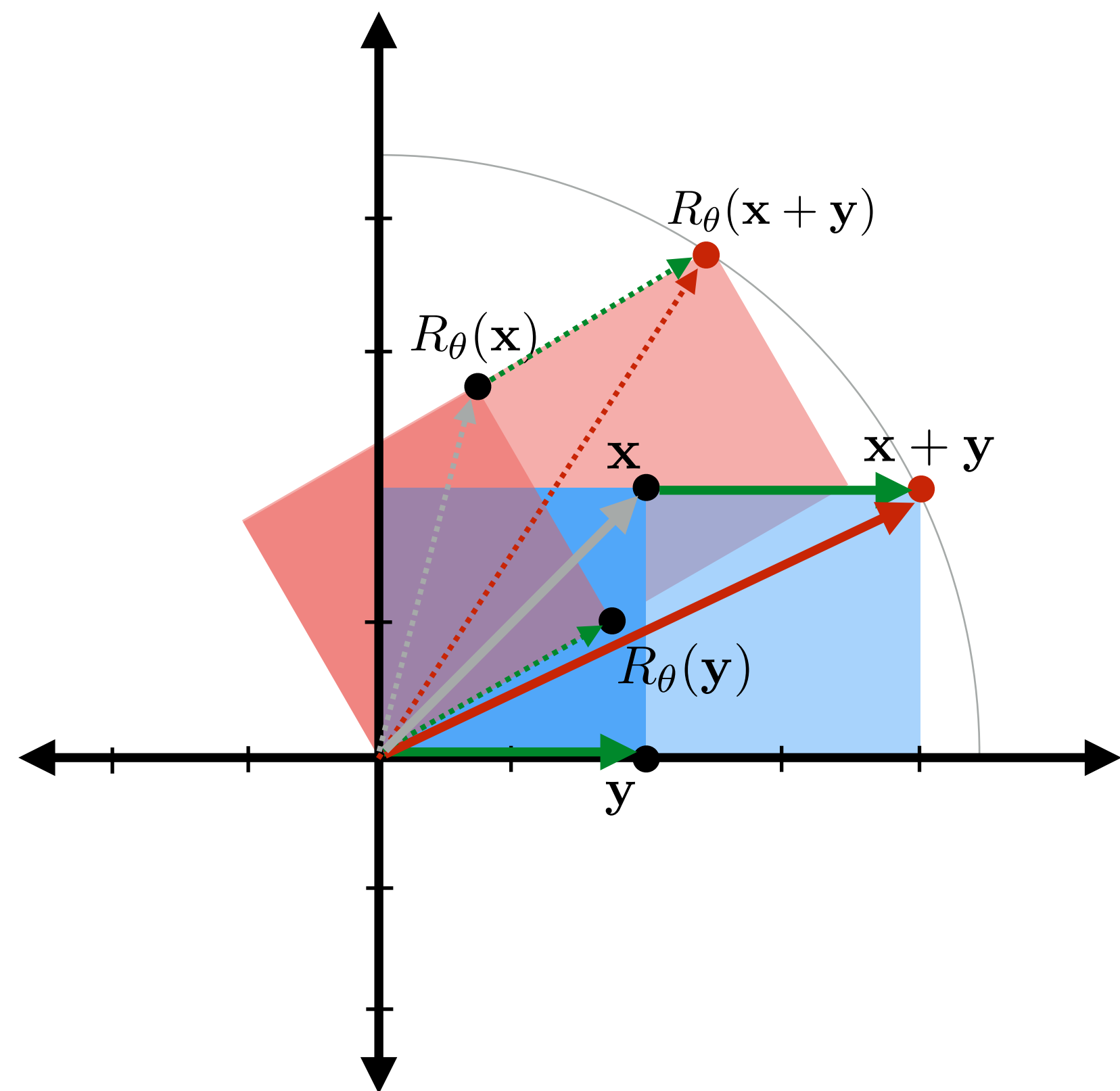
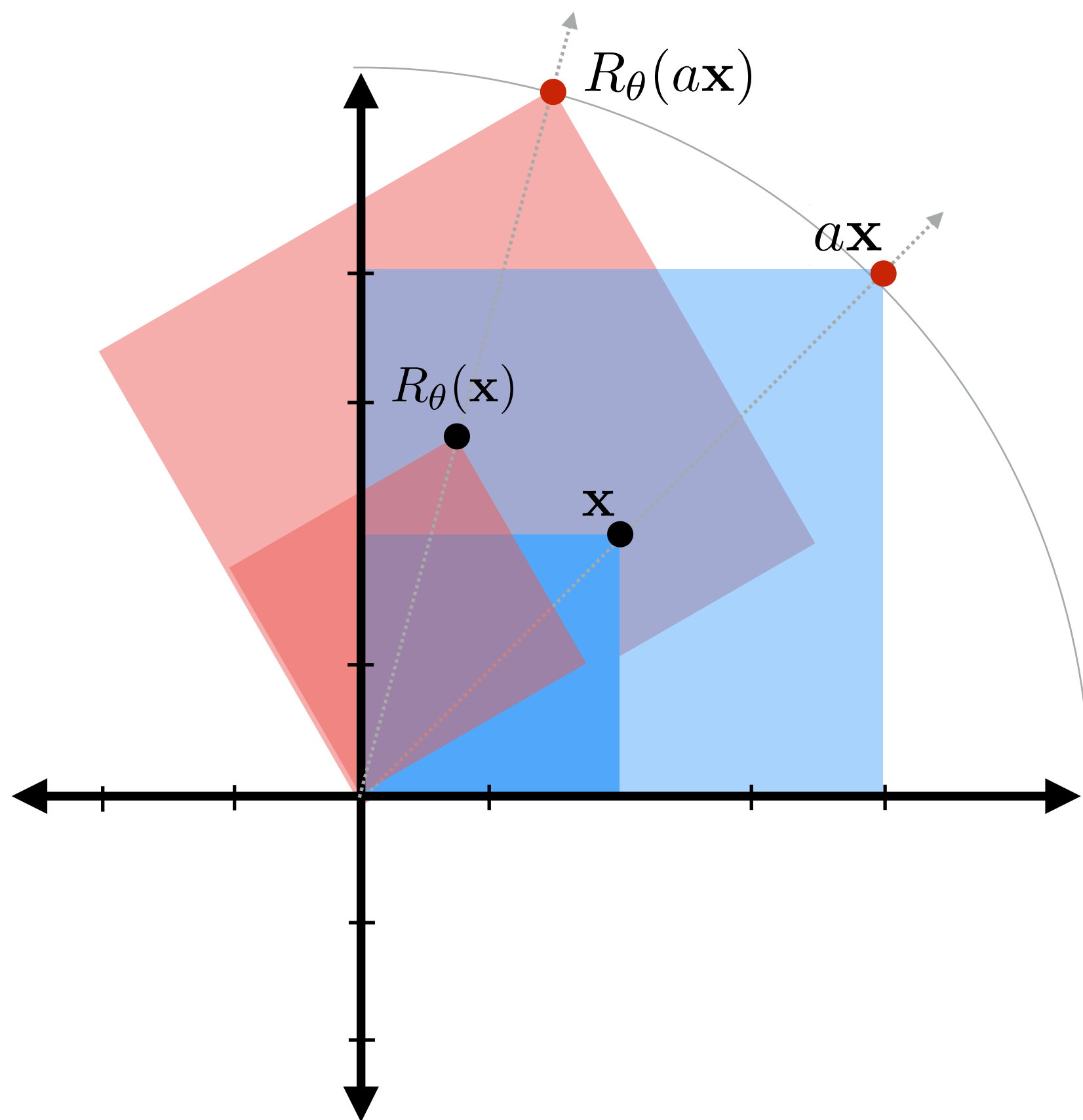

**Yes!**

# Translation

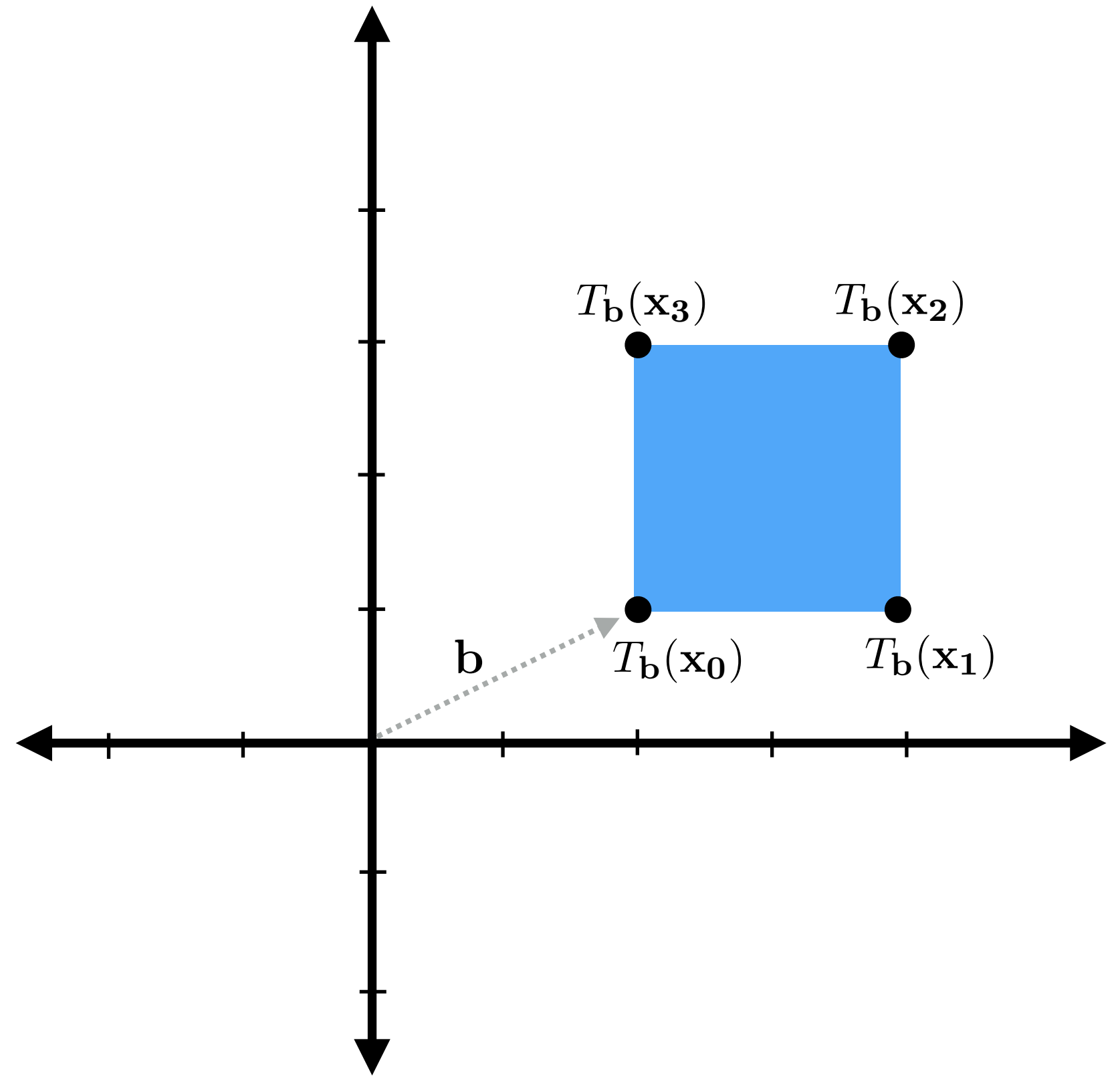
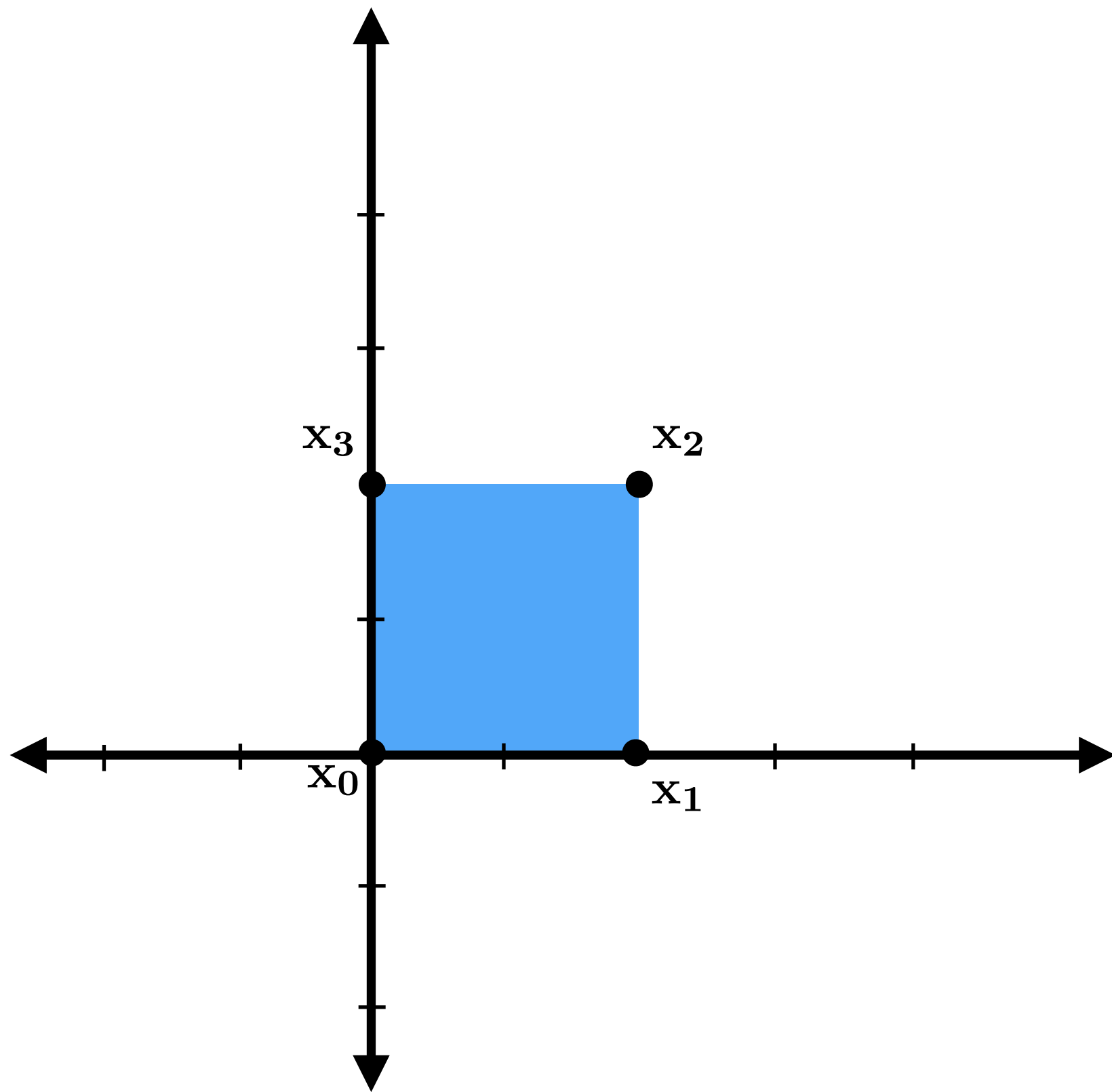

$T_b$  — “translate by  $\mathbf{b}$ ”

$$T_b(\mathbf{x}) = \mathbf{x} + \mathbf{b}$$

# Is translation linear?

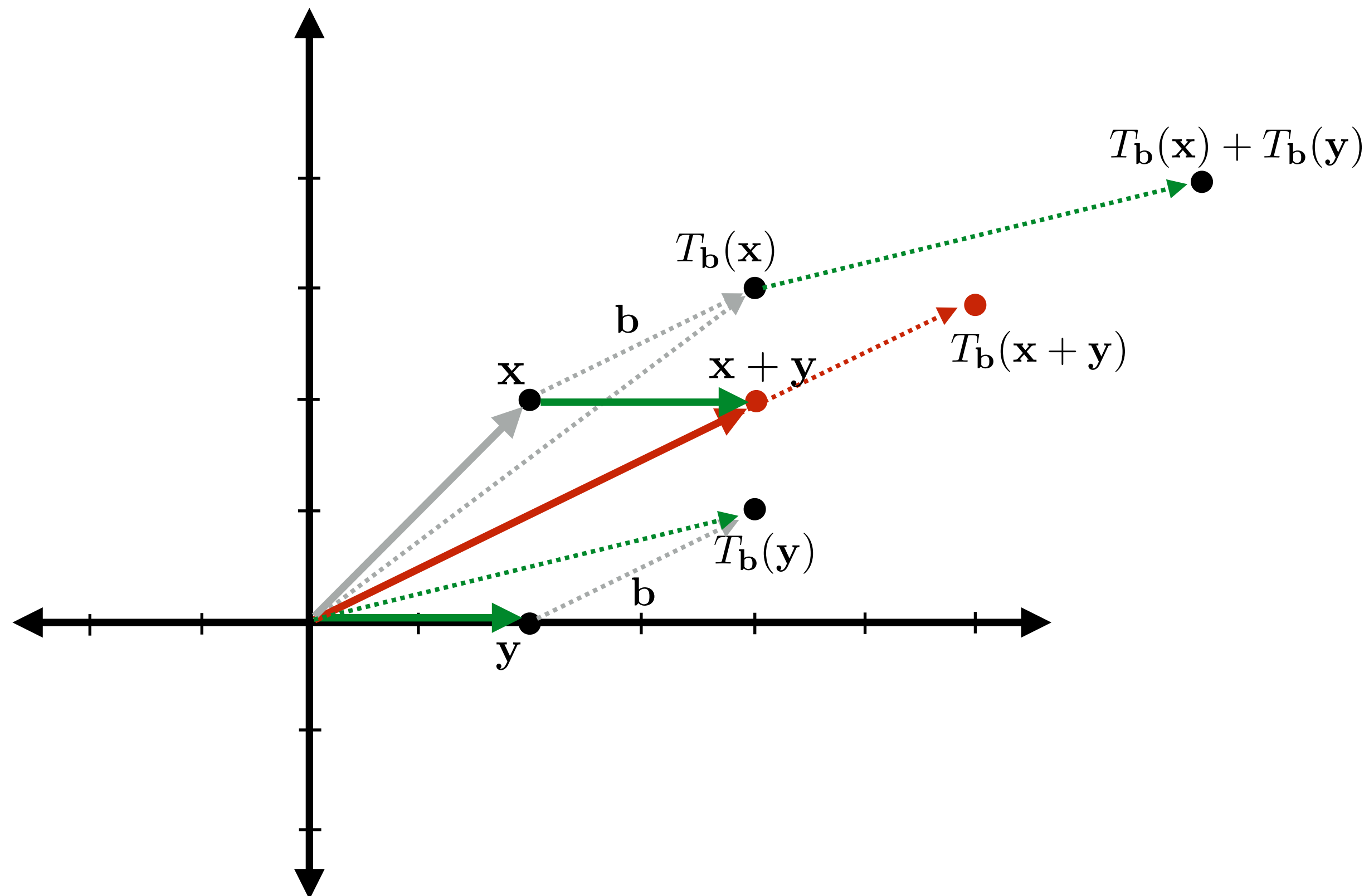

**No. Translation is affine.**

# Reflection

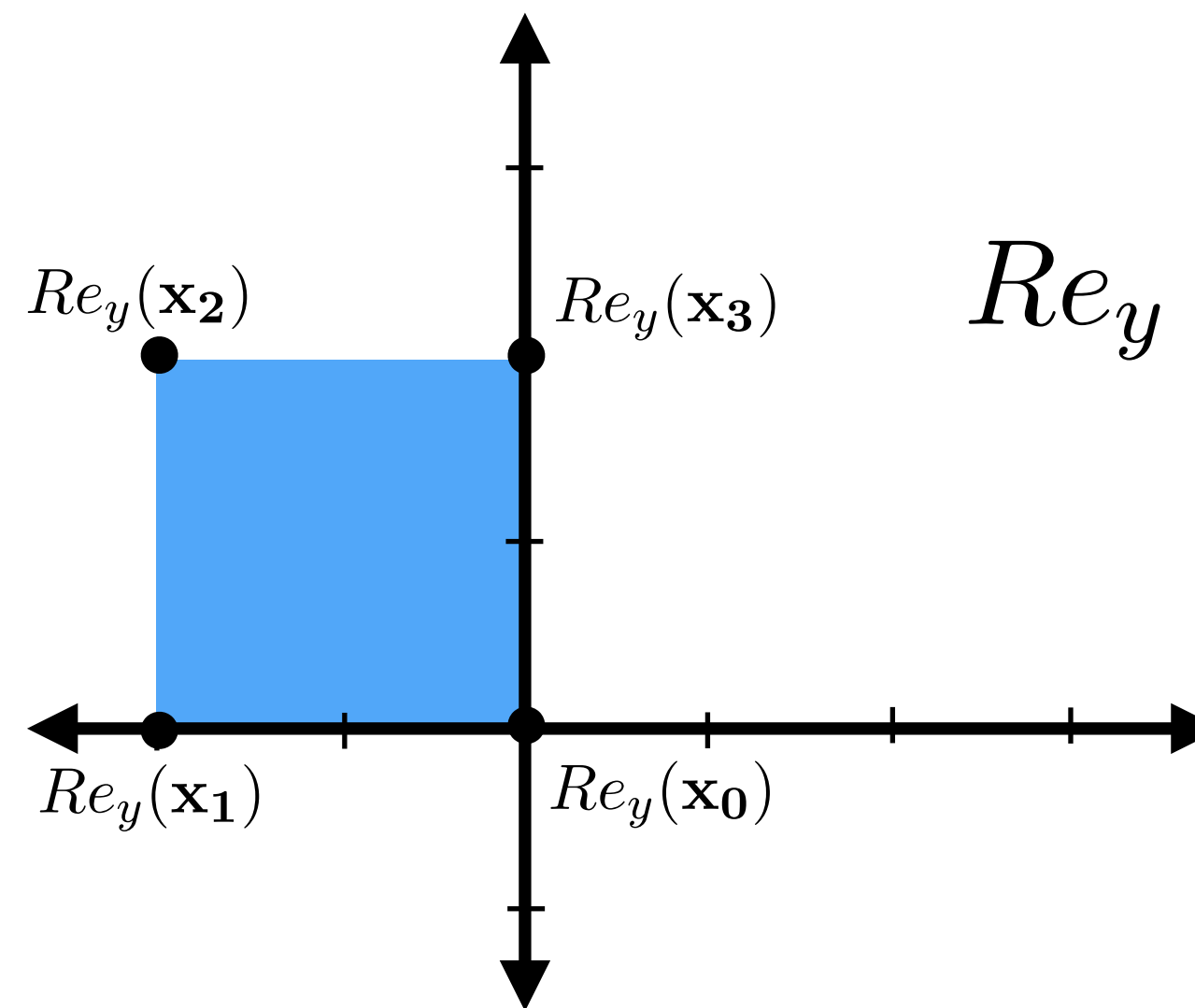
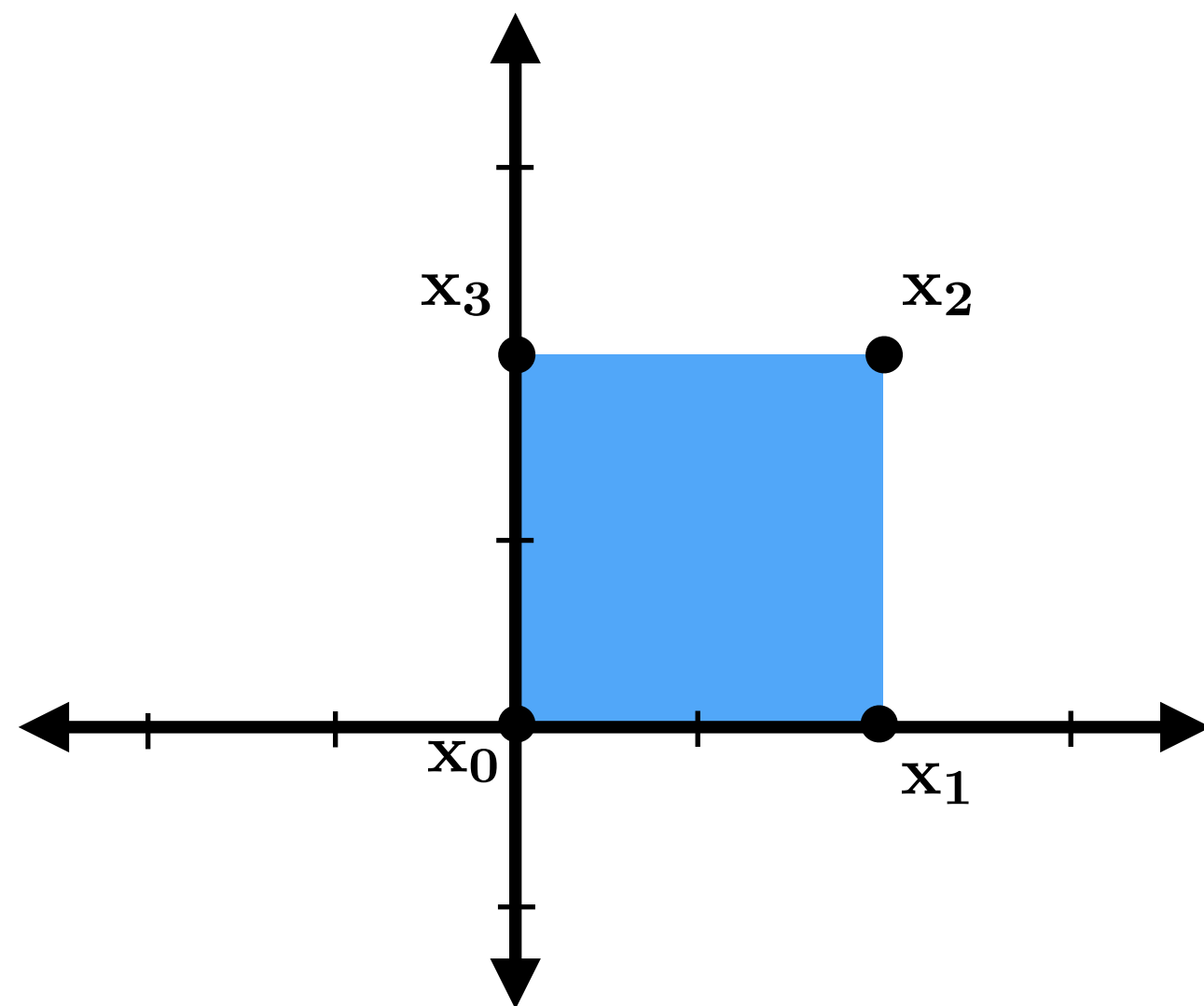

$Re_y =$  reflection about  $y$

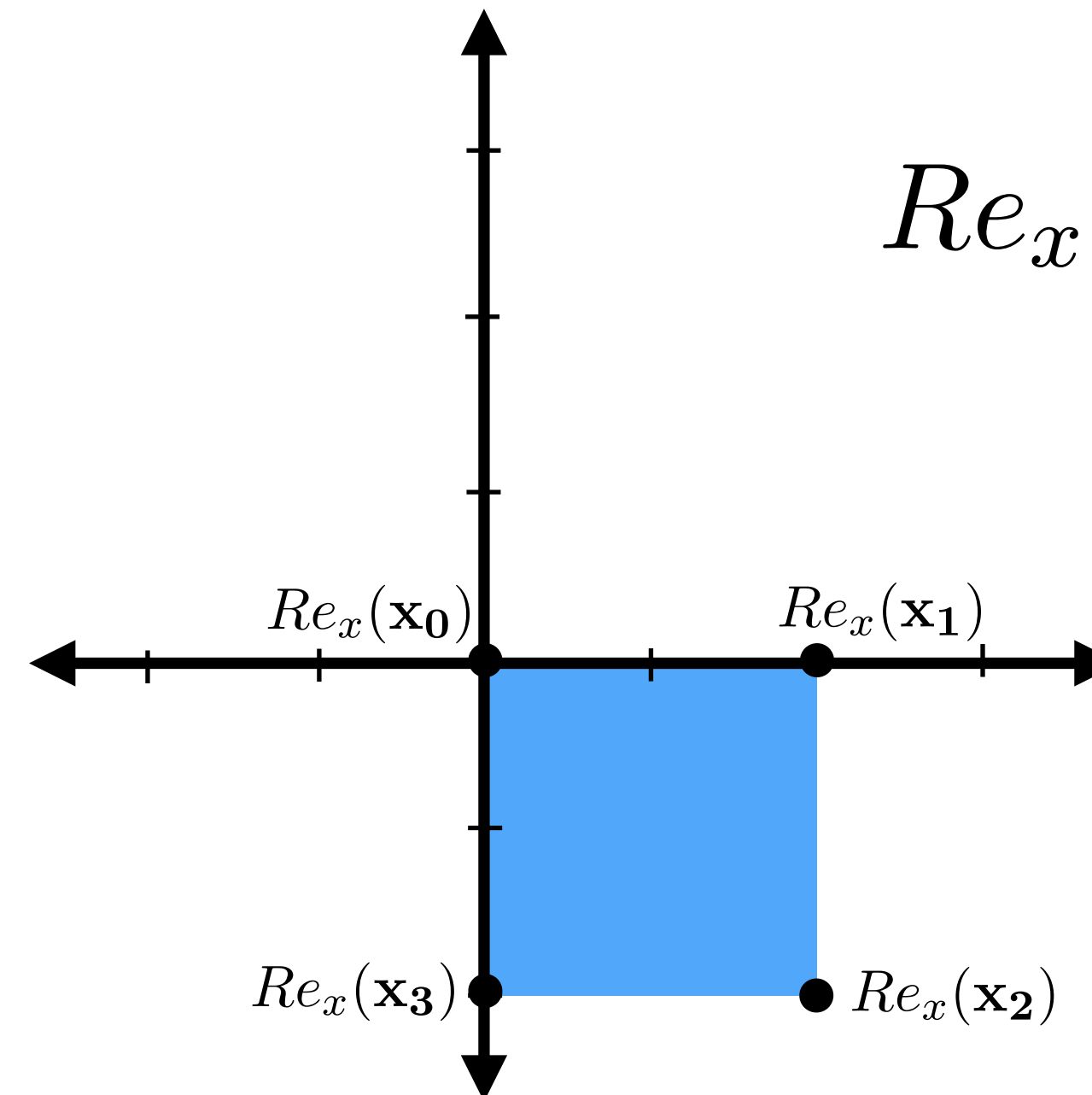

$Re_x =$  reflection about  $x$

# Shear (in $x$ direction)

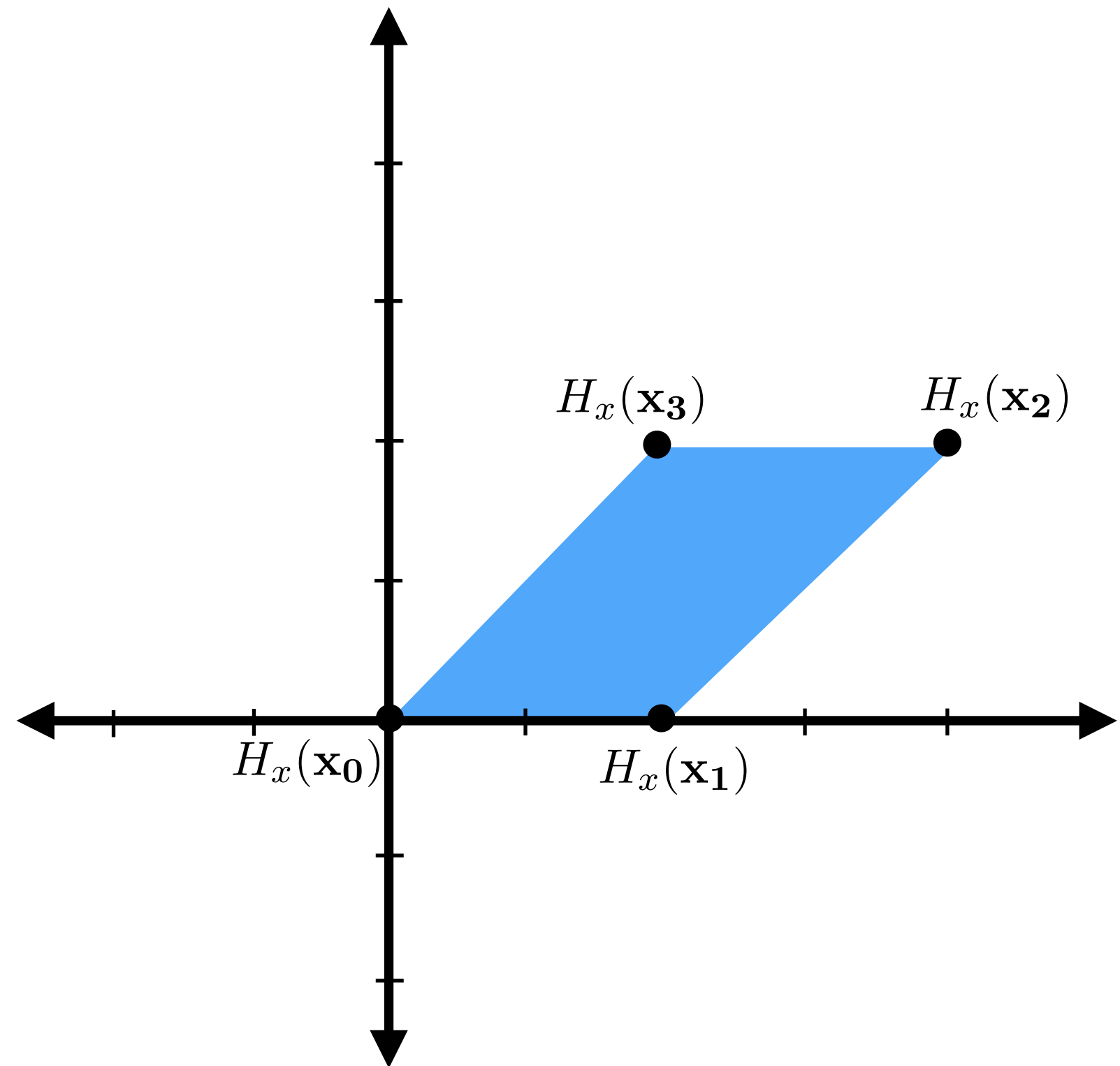
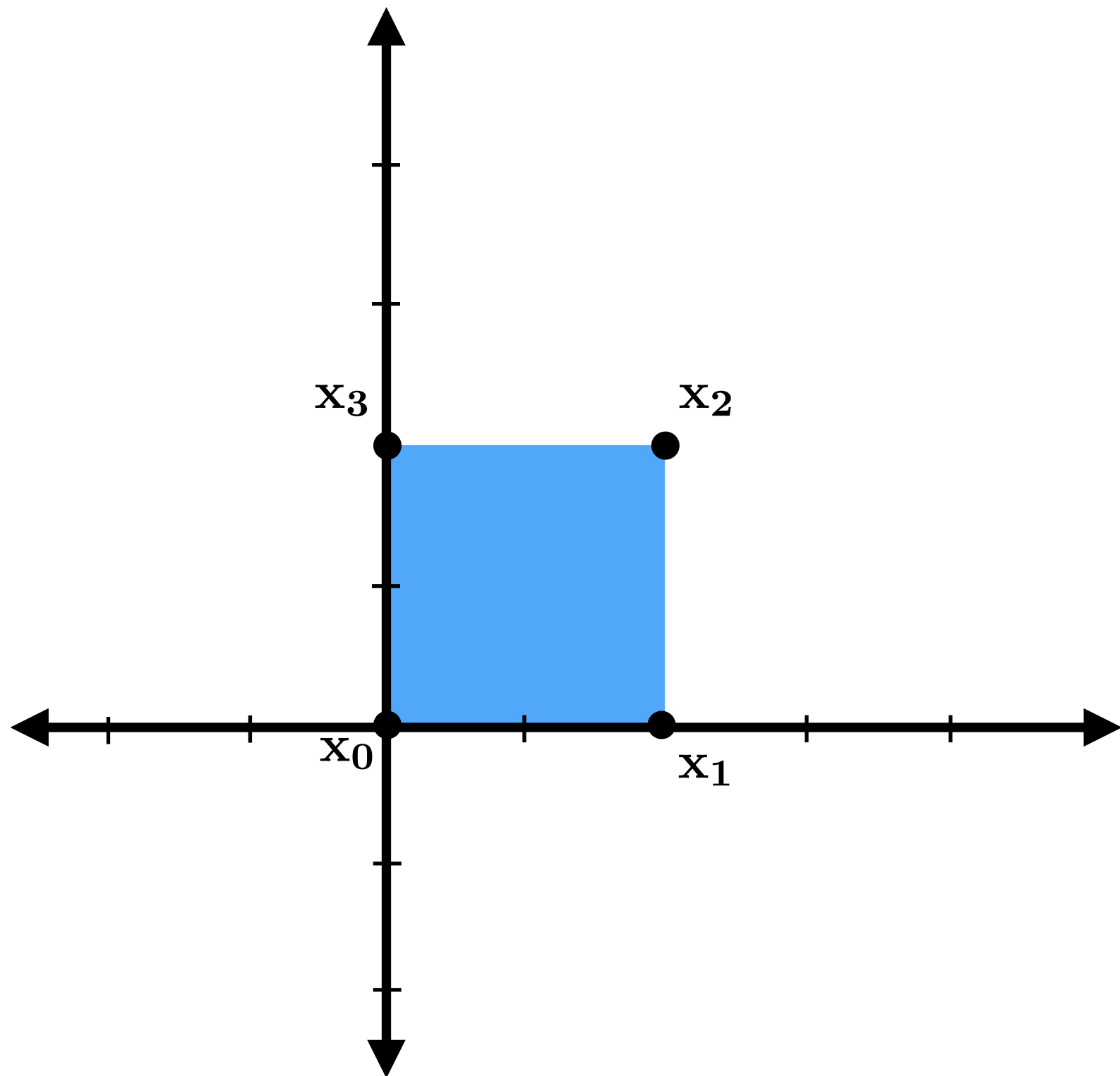

# Compose basic transformations to construct more complicated ones

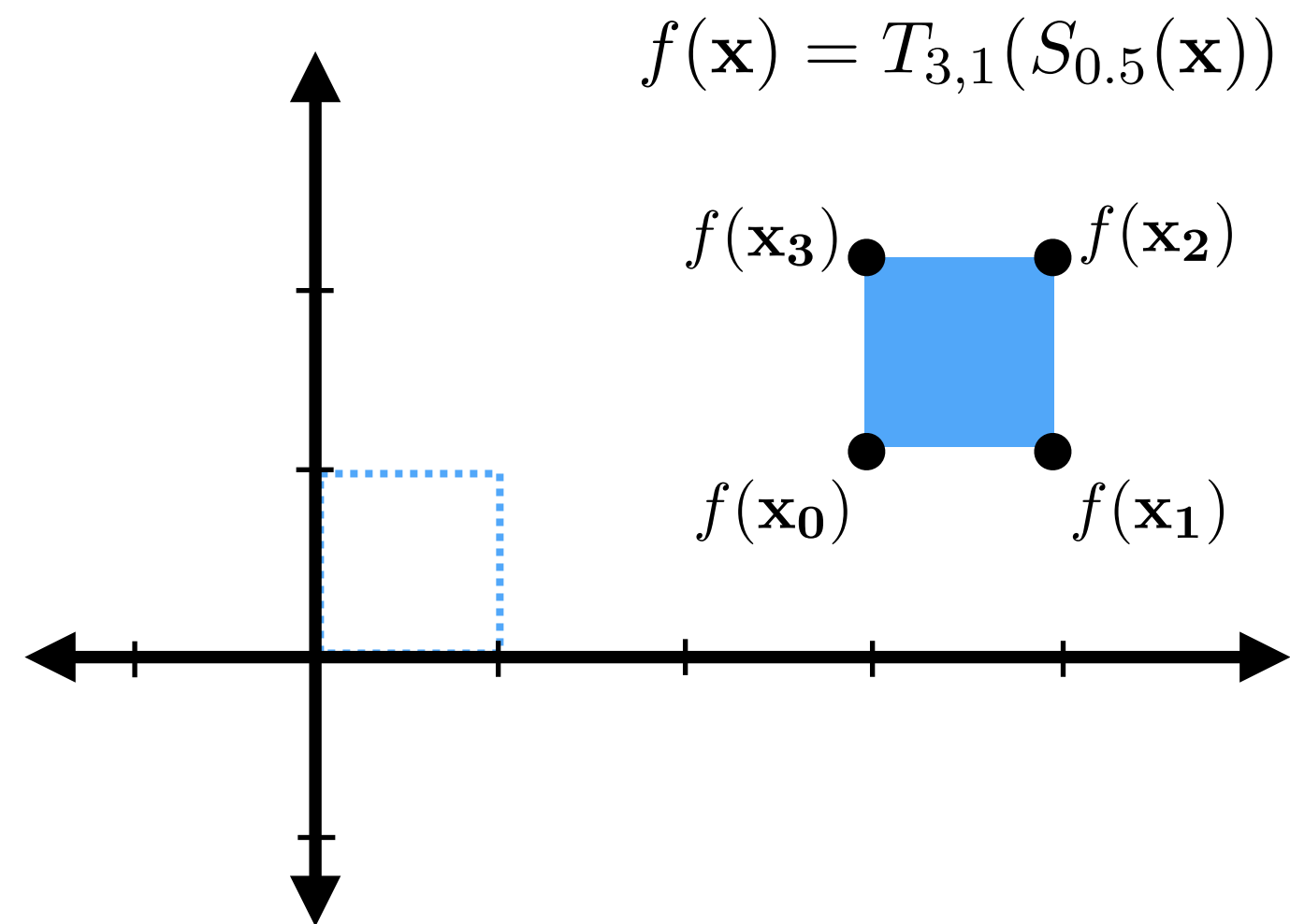
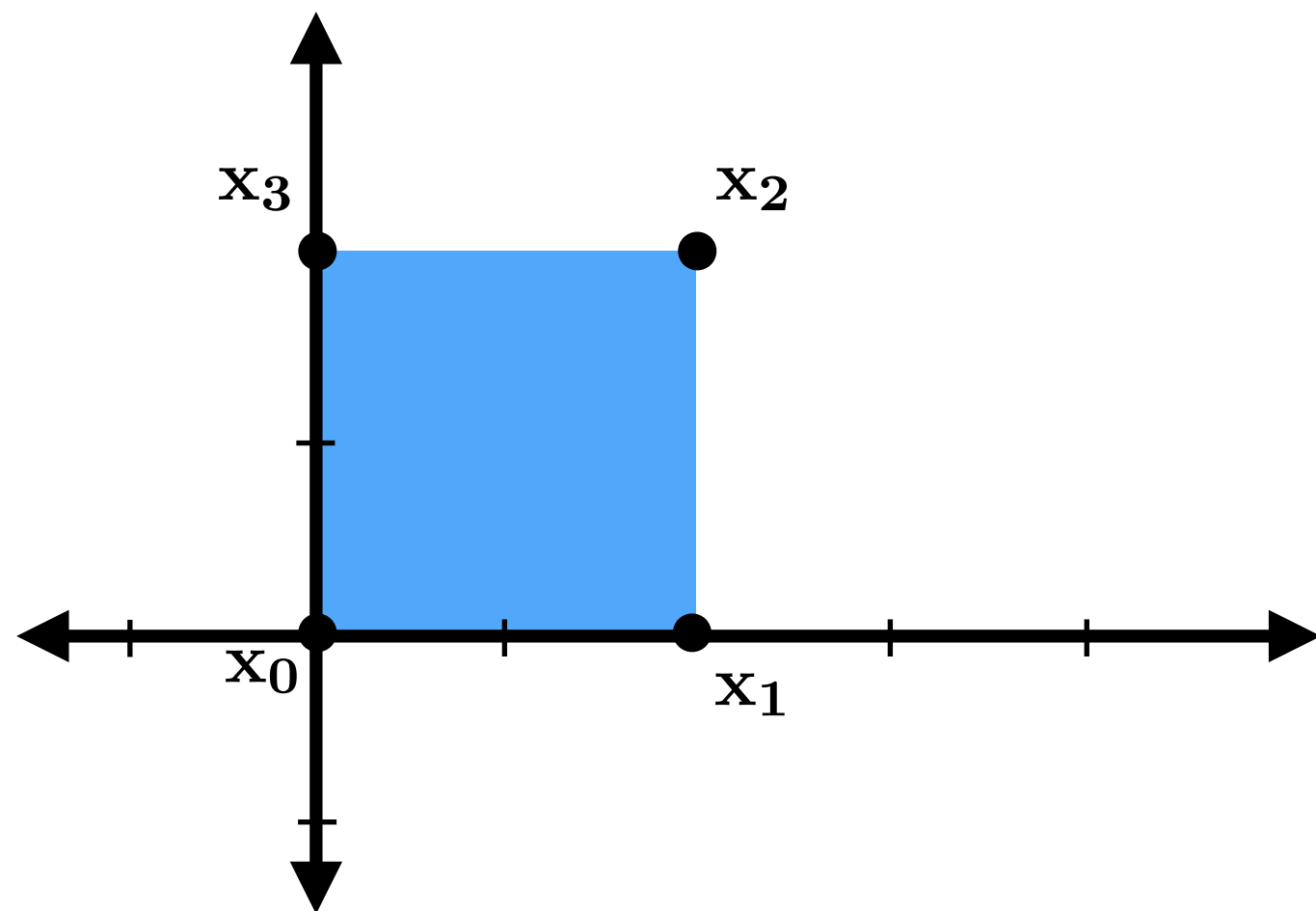

**Note: order of composition matters**

**Top-right: scale, then translate**

**Bottom-right: translate, then scale**

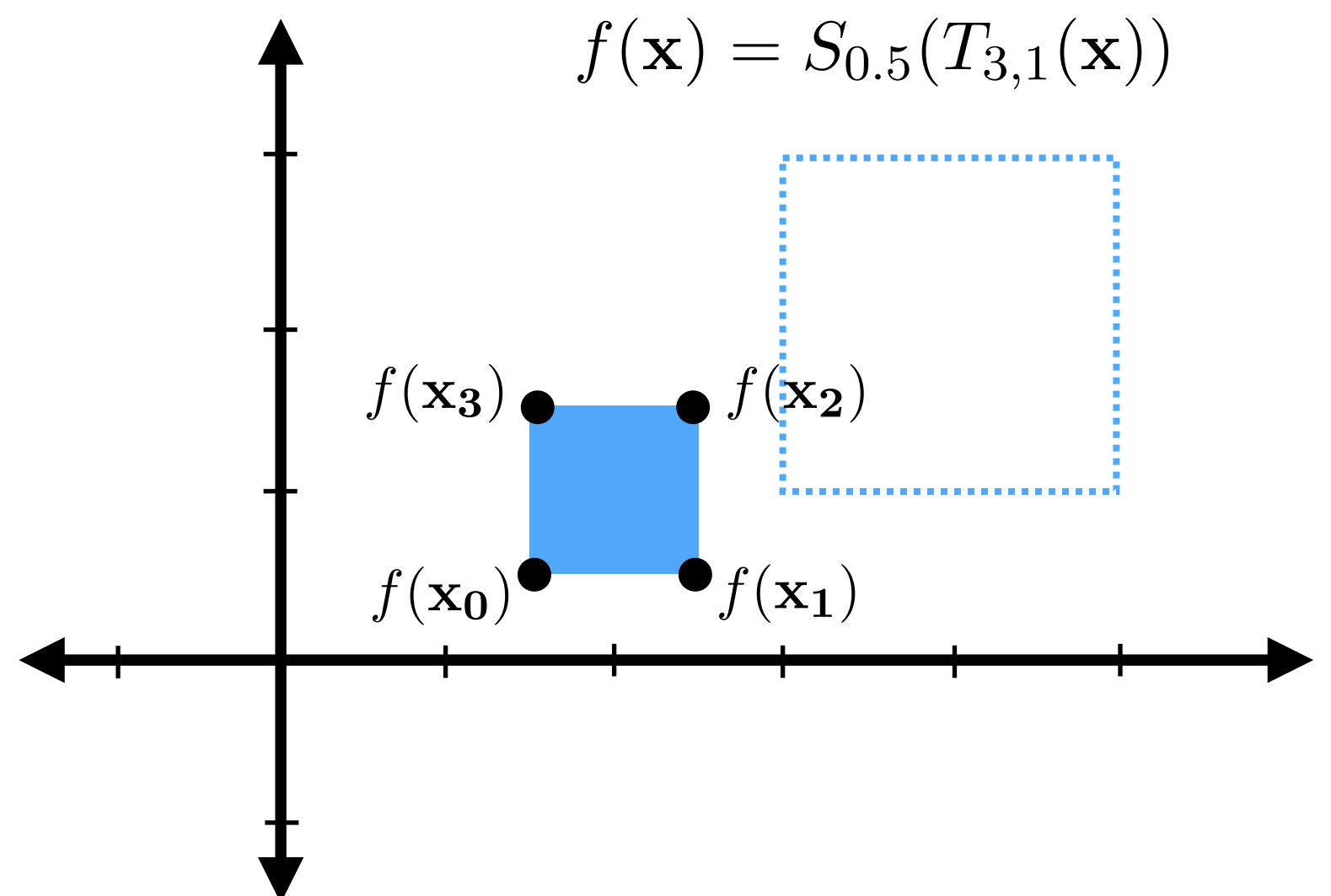



# How would you perform these transformations?

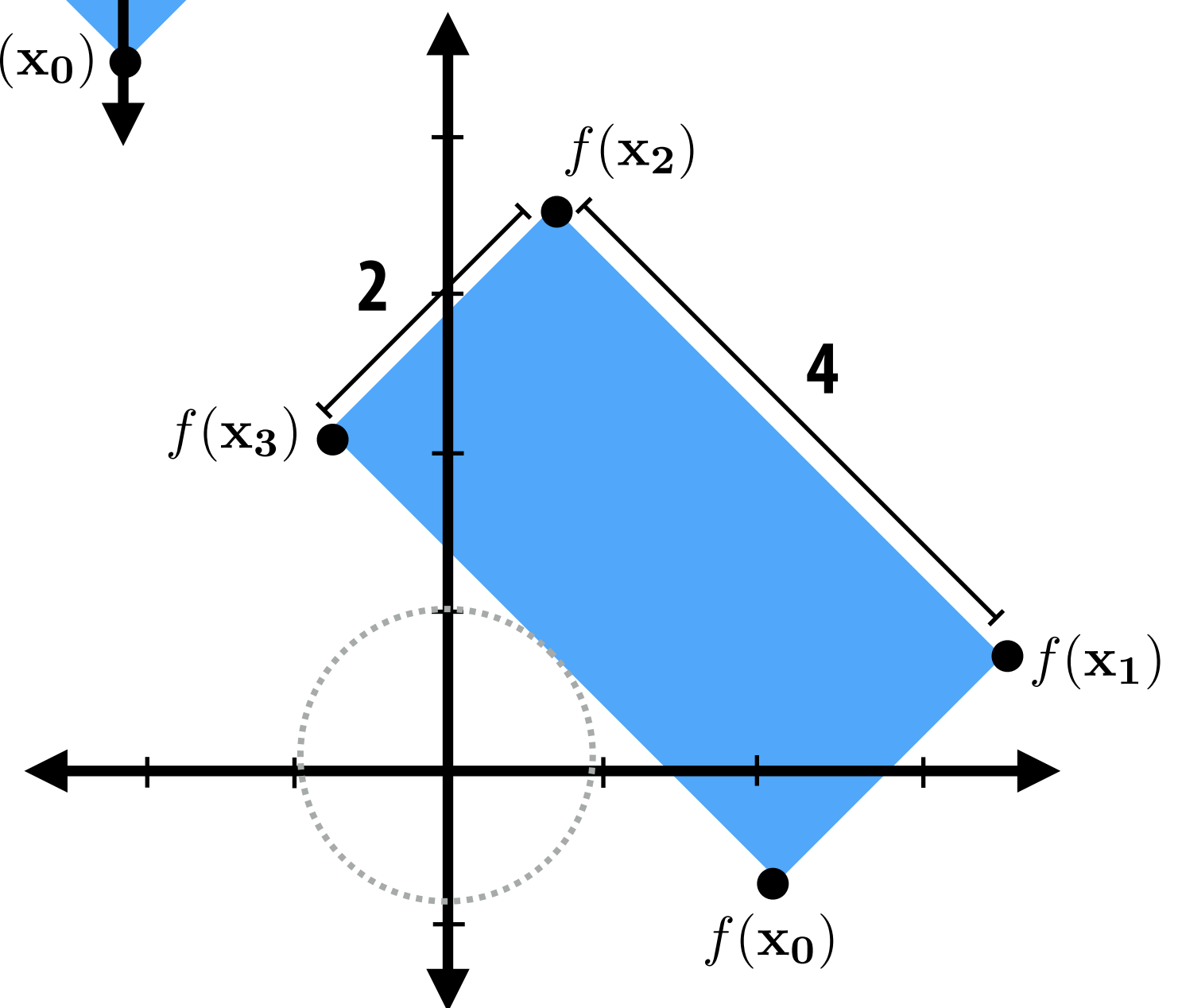
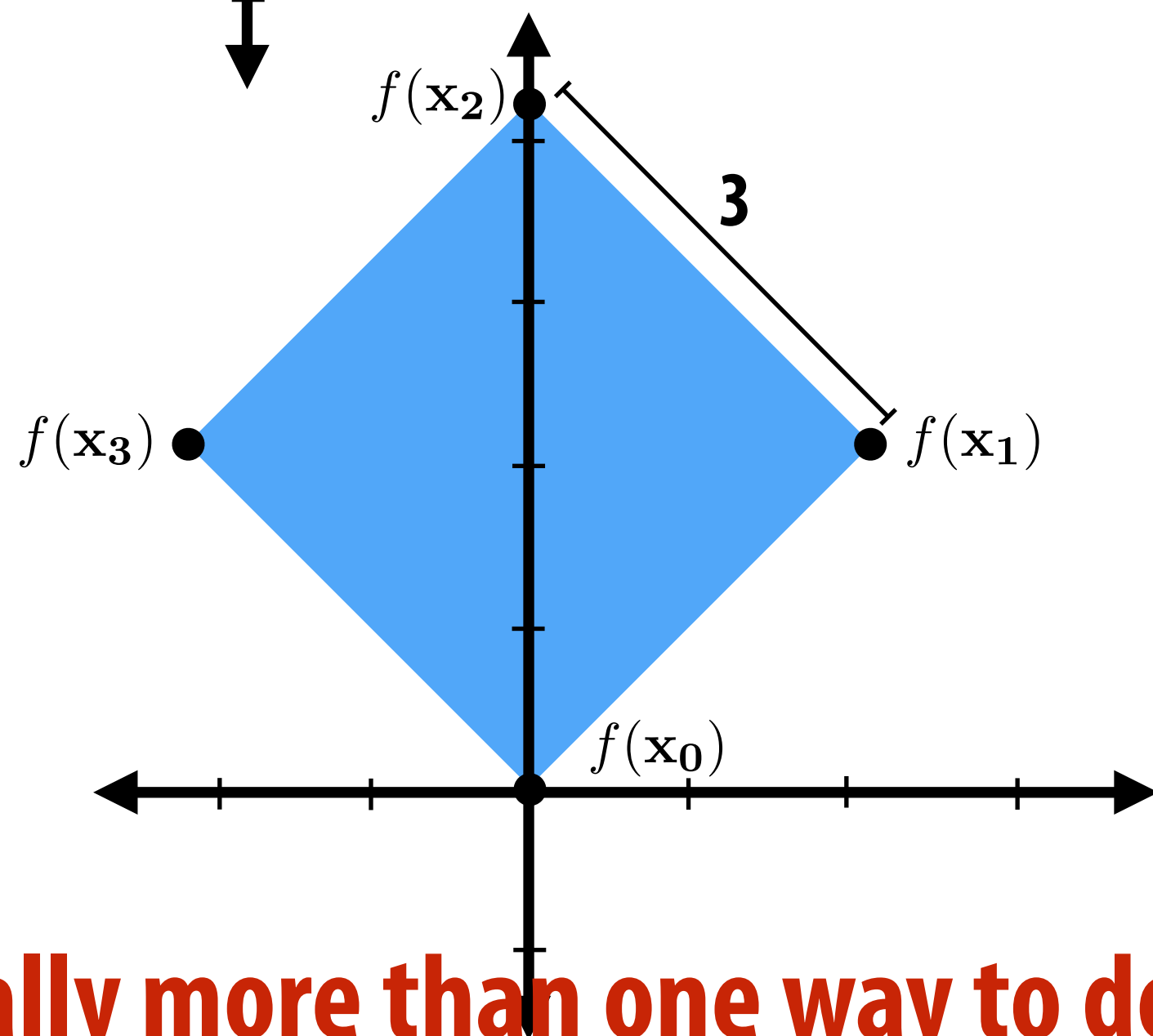
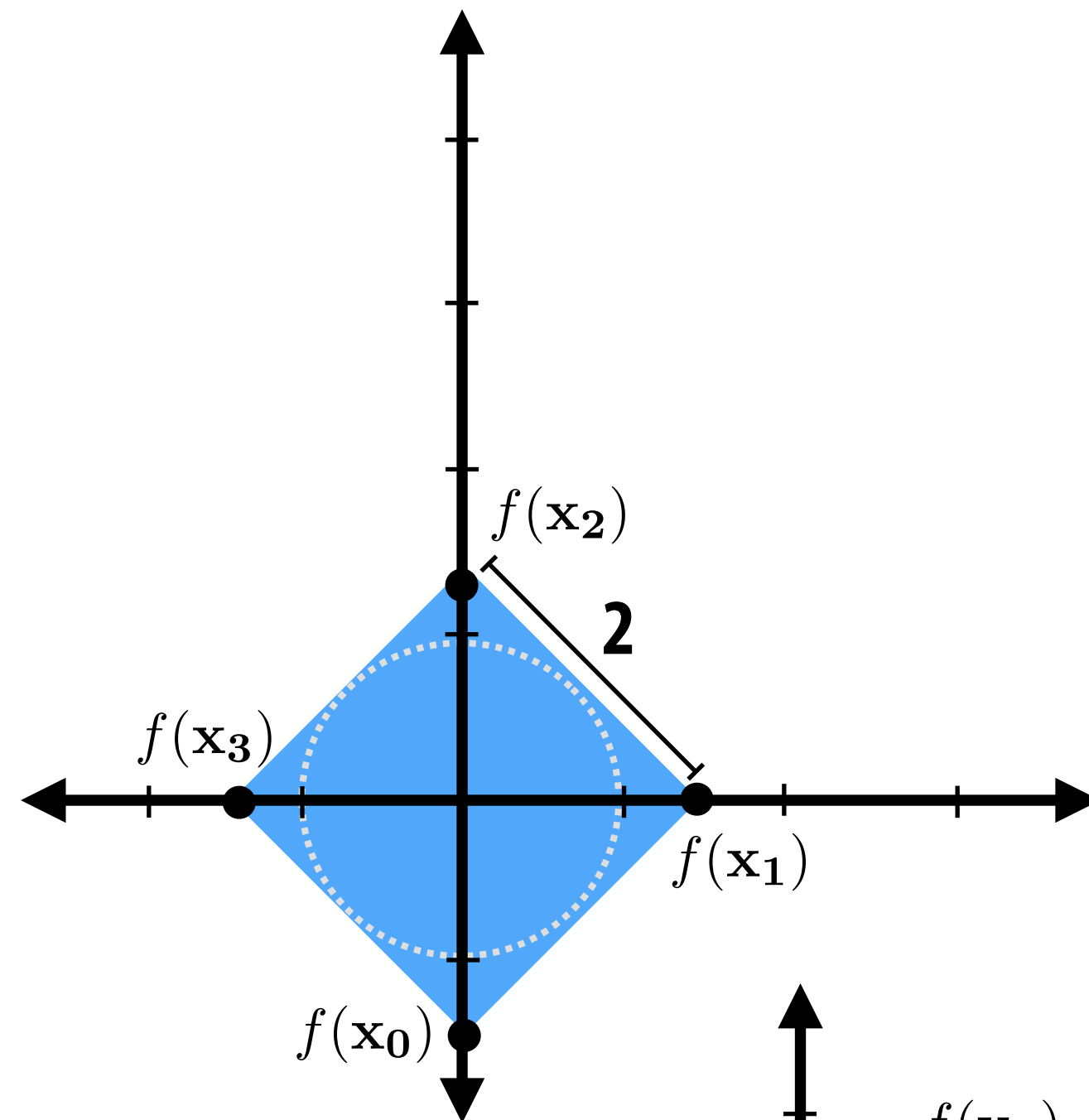
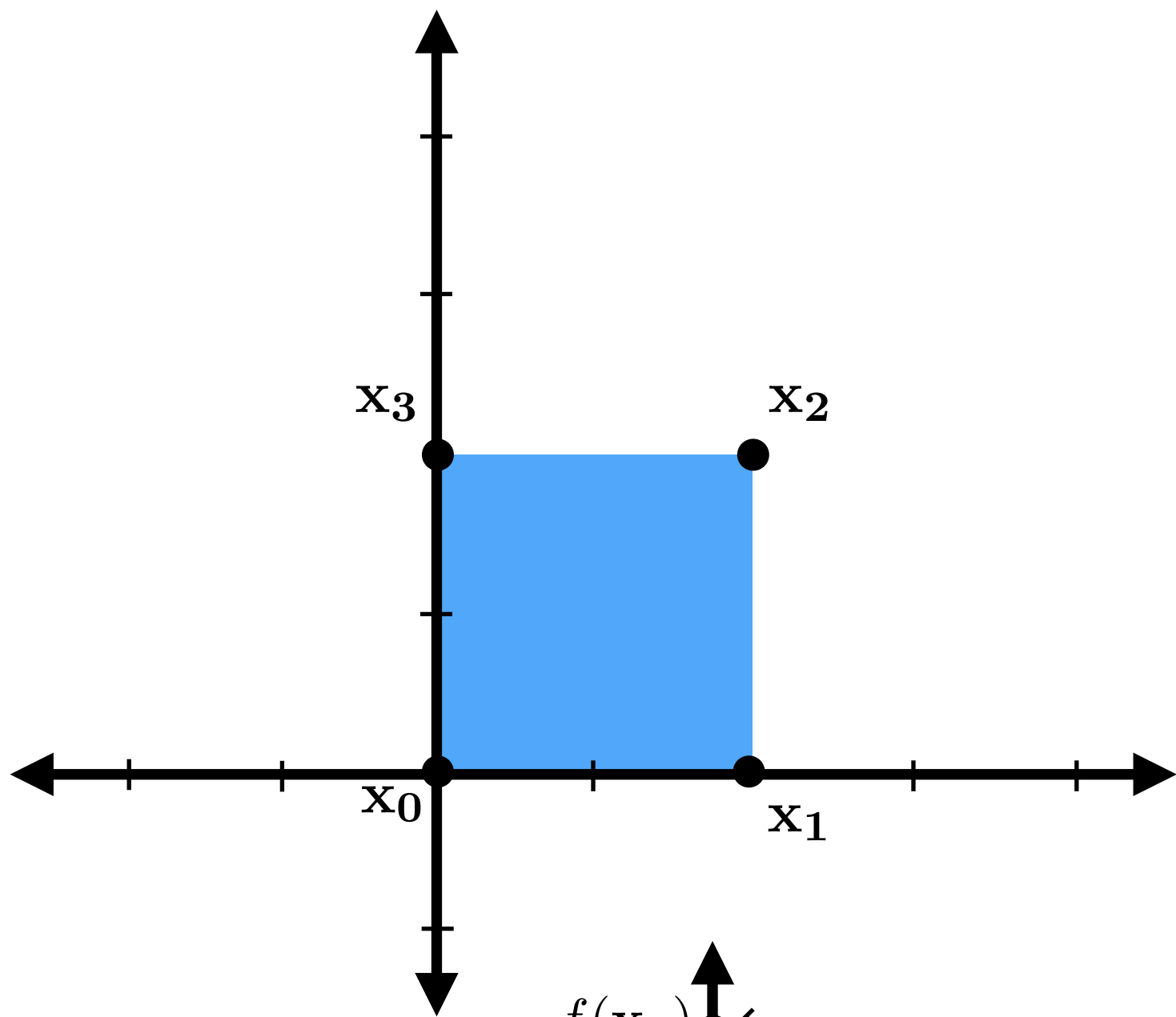

**Usually more than one way to do it!**

# Common task: rotate about a point $x$

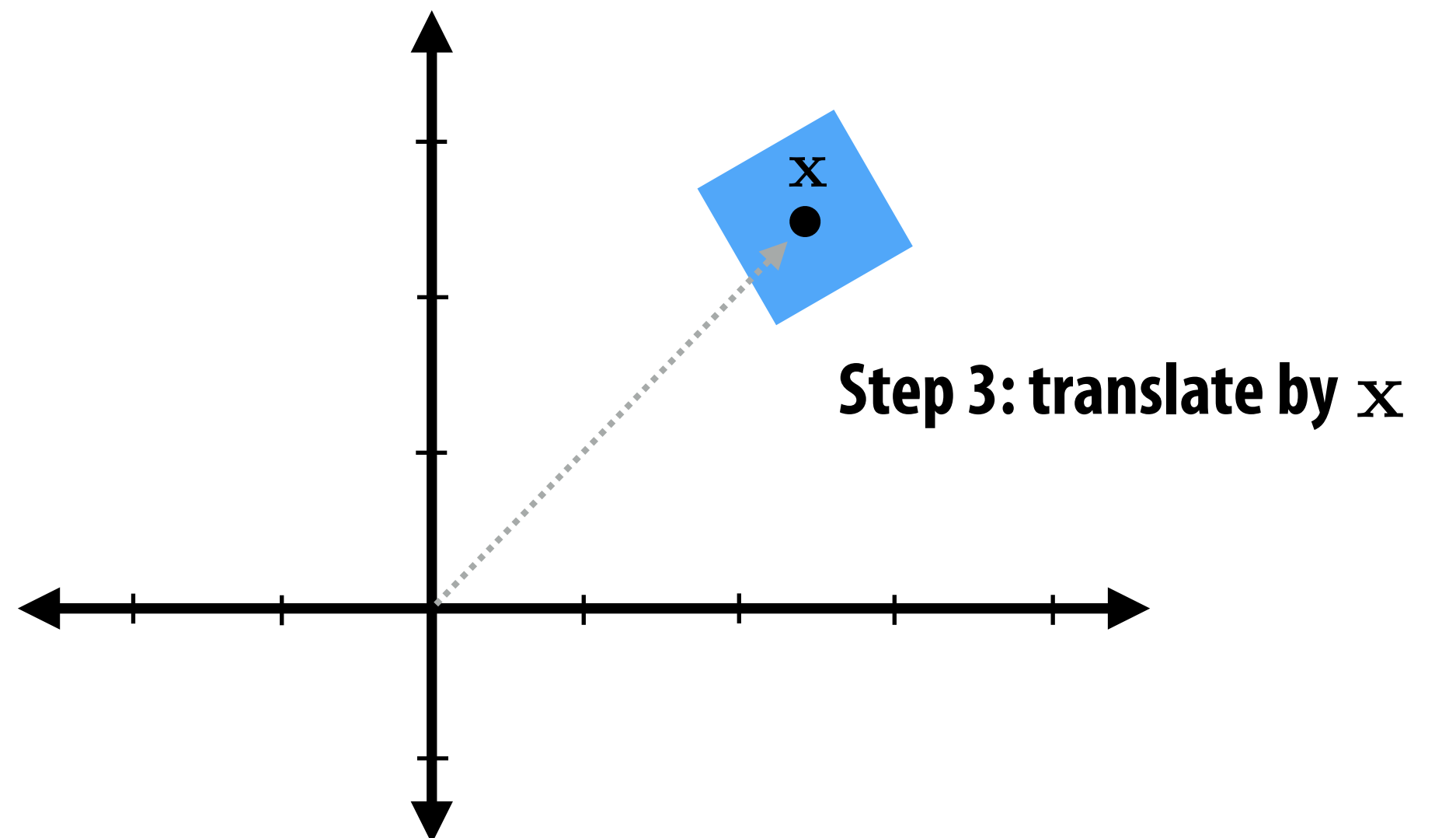
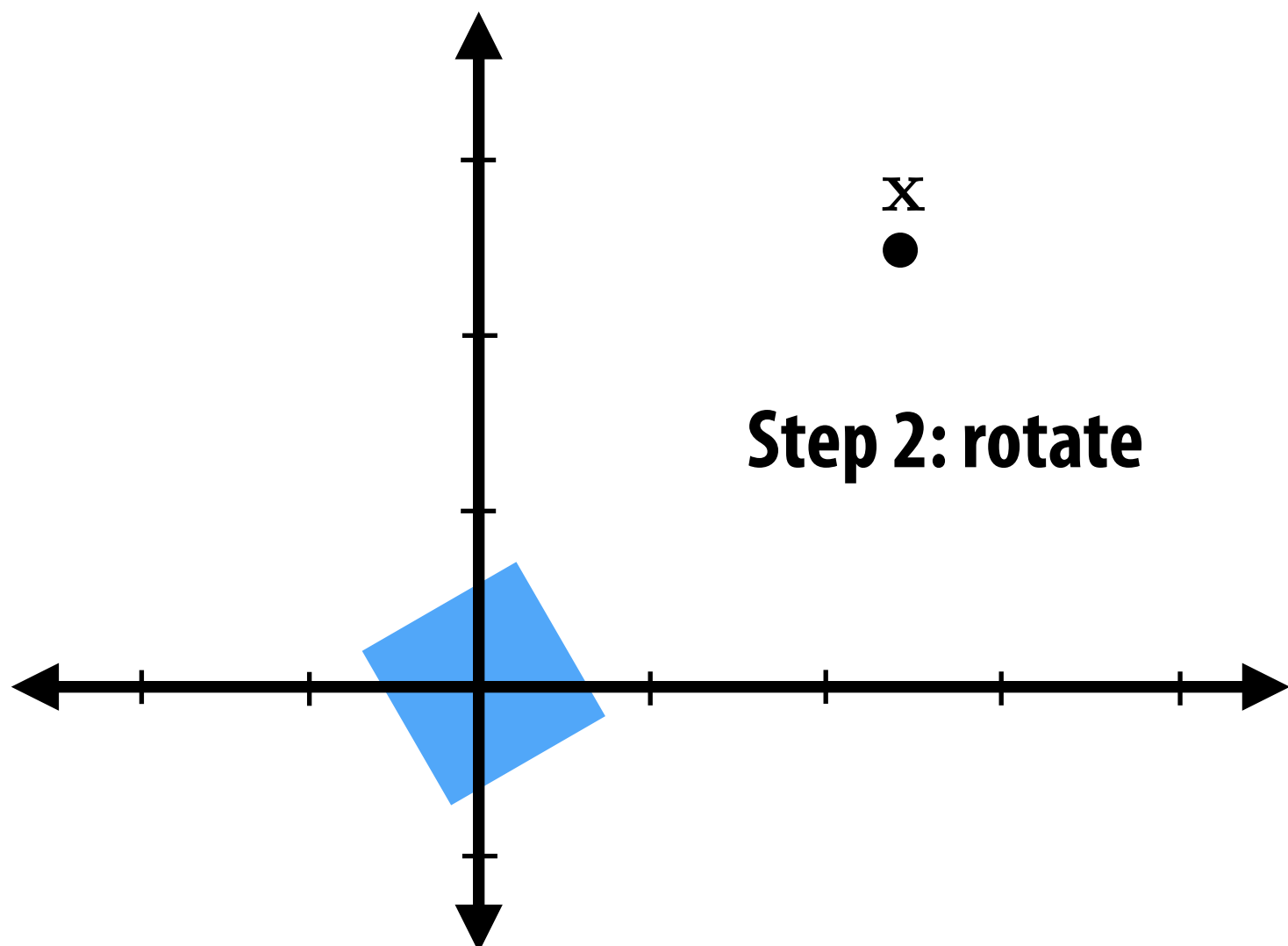
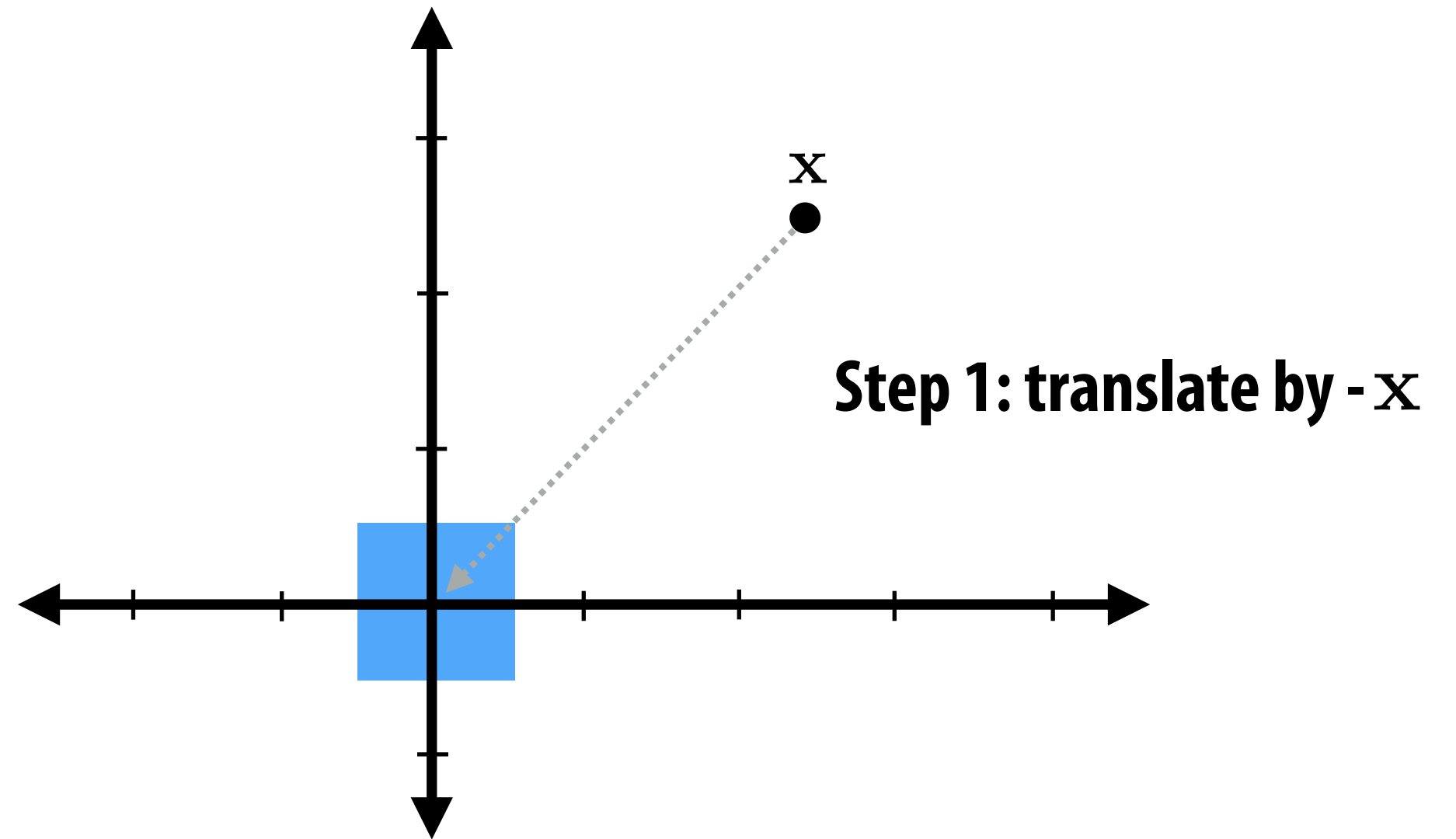
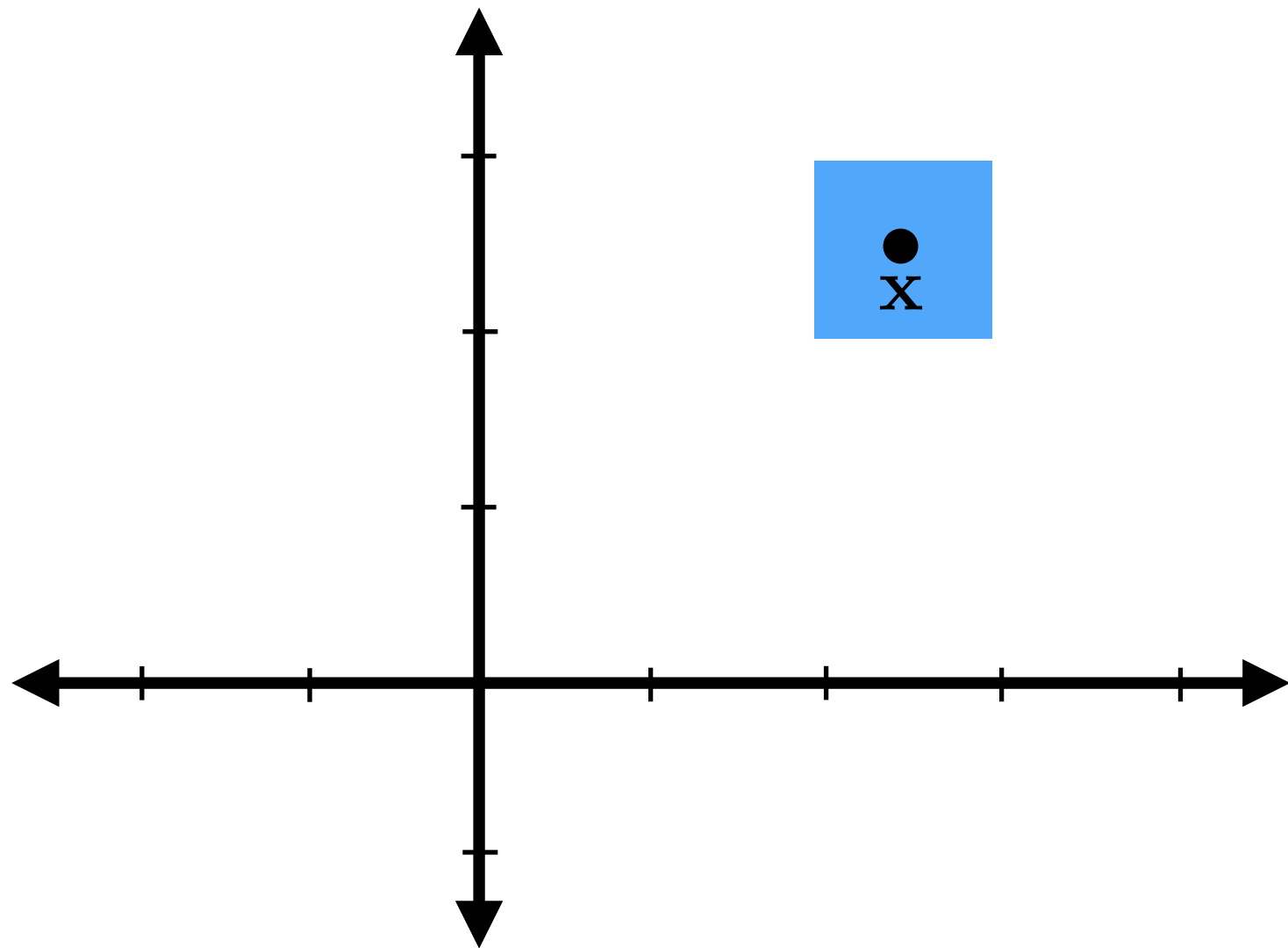

# Summary of basic transformations

## Linear:

$$f(\mathbf{x} + \mathbf{y}) = f(\mathbf{x}) + f(\mathbf{y})$$

$$f(a\mathbf{x}) = af(\mathbf{x})$$

Scale

Rotation

Reflection

Shear

## Not linear:

Translation

## Affine:

Composition of linear transform + translation  
(all examples on previous two slides)

$$f(\mathbf{x}) = g(\mathbf{x}) + \mathbf{b}$$

Not affine: perspective projection (will discuss later)

## Euclidean: (Isometries)

Preserve distance between points (preserves length)

$$|f(\mathbf{x}) - f(\mathbf{y})| = |\mathbf{x} - \mathbf{y}|$$

Translation

Rotation

Reflection

“Rigid body” transformations are distance-preserving motions that also preserve *orientation* (i.e., does not include reflection)

# **Representing Transformations in Coordinates**

# Review: representing points in a coordinate space

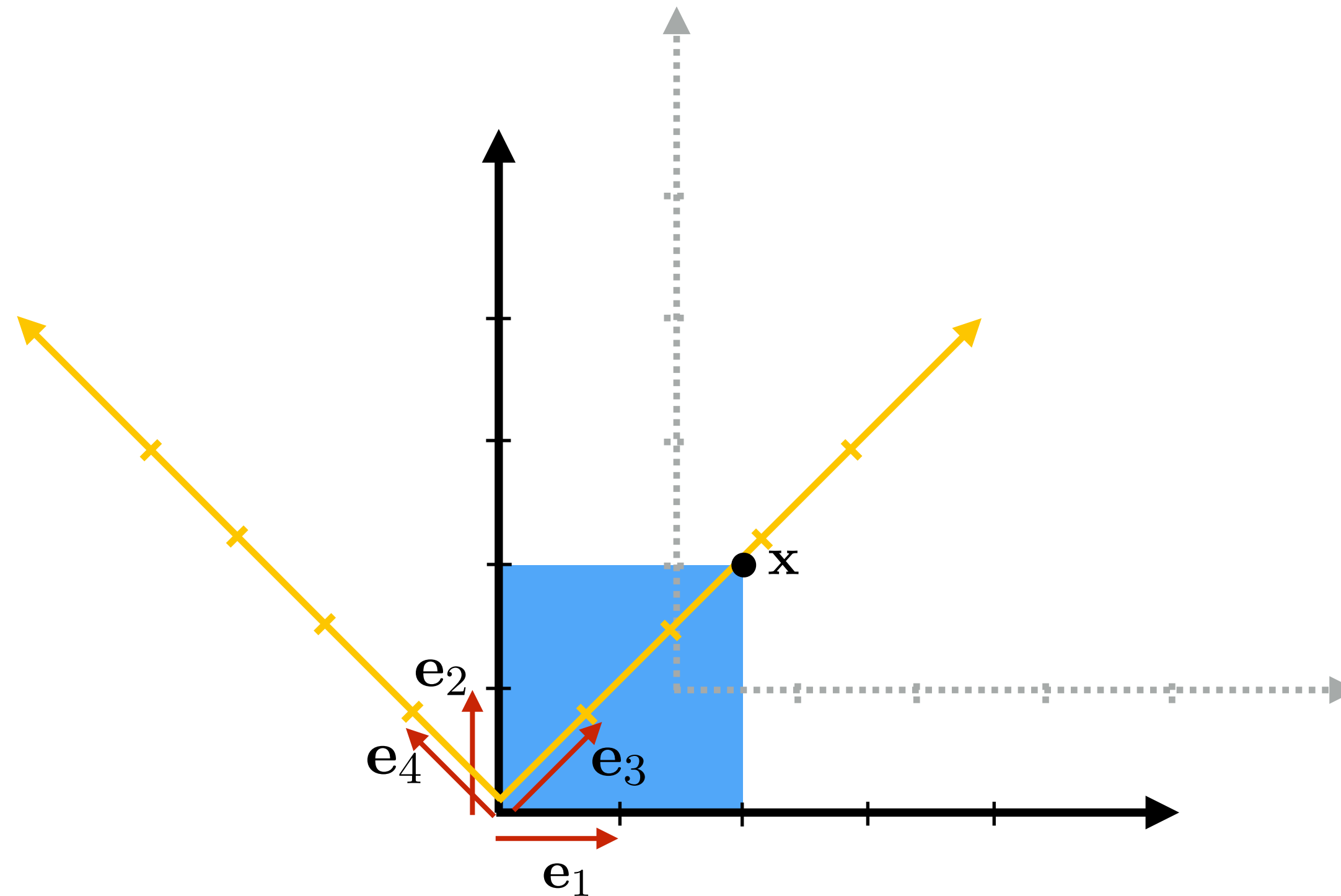

Consider coordinate space defined by orthogonal vectors  $e_1$  and  $e_2$

$$\mathbf{x} = 2\mathbf{e}_1 + 2\mathbf{e}_2$$

$$\mathbf{x} = \begin{bmatrix} 2 & 2 \end{bmatrix}$$

$\mathbf{x} = \begin{bmatrix} 0.5 & 1 \end{bmatrix}$  in coordinate space defined by  $e_1$  and  $e_2$ , with origin at  $(1.5, 1)$

$\mathbf{x} = \begin{bmatrix} \sqrt{8} & 0 \end{bmatrix}$  in coordinate space defined by  $e_3$  and  $e_4$ , with origin at  $(0, 0)$

# Review: 2D matrix multiplication

$$\begin{bmatrix} a & b \\ c & d \end{bmatrix} \begin{bmatrix} x \\ y \end{bmatrix} =$$
$$x \begin{bmatrix} a \\ c \end{bmatrix} + y \begin{bmatrix} b \\ d \end{bmatrix} =$$
$$\begin{bmatrix} ax + by \\ cx + dy \end{bmatrix}$$

- **Matrix multiplication is linear combination of columns**
- **Encodes a linear map!**

# Linear maps via matrices

- **Example: suppose I have a linear map**

$$f(\mathbf{u}) = u_1 \mathbf{a}_1 + u_2 \mathbf{a}_2$$

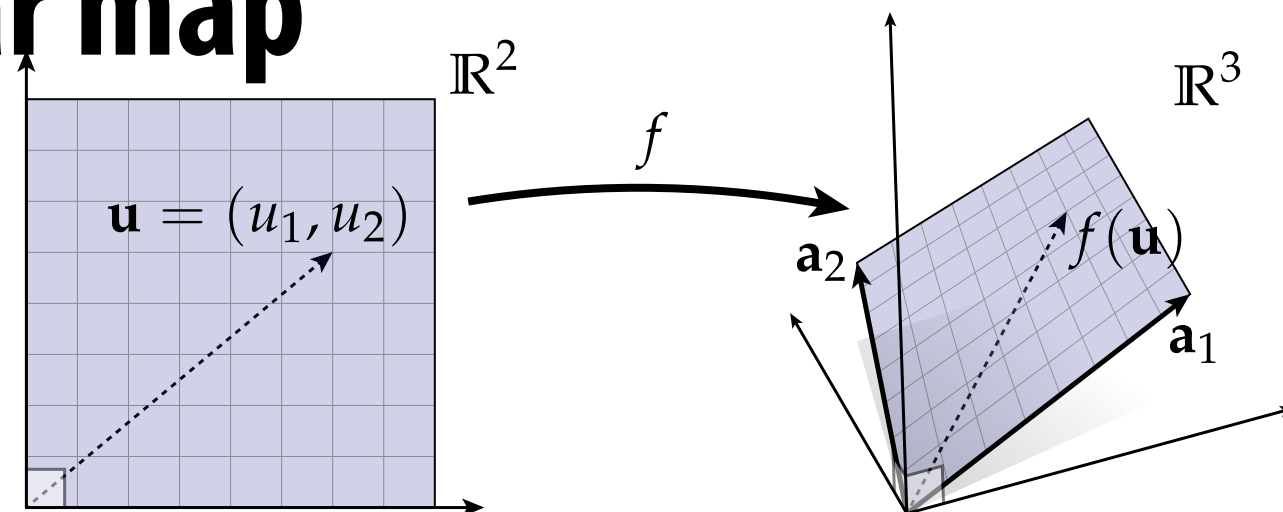

- **Encoding as a matrix: “a” vectors become matrix columns:**

$$A := \begin{bmatrix} a_{1,x} & a_{2,x} \\ a_{1,y} & a_{2,y} \\ a_{1,z} & a_{2,z} \end{bmatrix}$$

- **Matrix-vector multiply computes same output as original map:**

$$\begin{bmatrix} a_{1,x} & a_{2,x} \\ a_{1,y} & a_{2,y} \\ a_{1,z} & a_{2,z} \end{bmatrix} \begin{bmatrix} u_1 \\ u_2 \end{bmatrix} = \begin{bmatrix} a_{1,x}u_1 + a_{2,x}u_2 \\ a_{1,y}u_1 + a_{2,y}u_2 \\ a_{1,z}u_1 + a_{2,z}u_2 \end{bmatrix} = u_1 \mathbf{a}_1 + u_2 \mathbf{a}_2$$

# Linear transformations in 2D can be represented as 2x2 matrices

Consider non-uniform scale:  $S_s = \begin{bmatrix} s_x & 0 \\ 0 & s_y \end{bmatrix}$

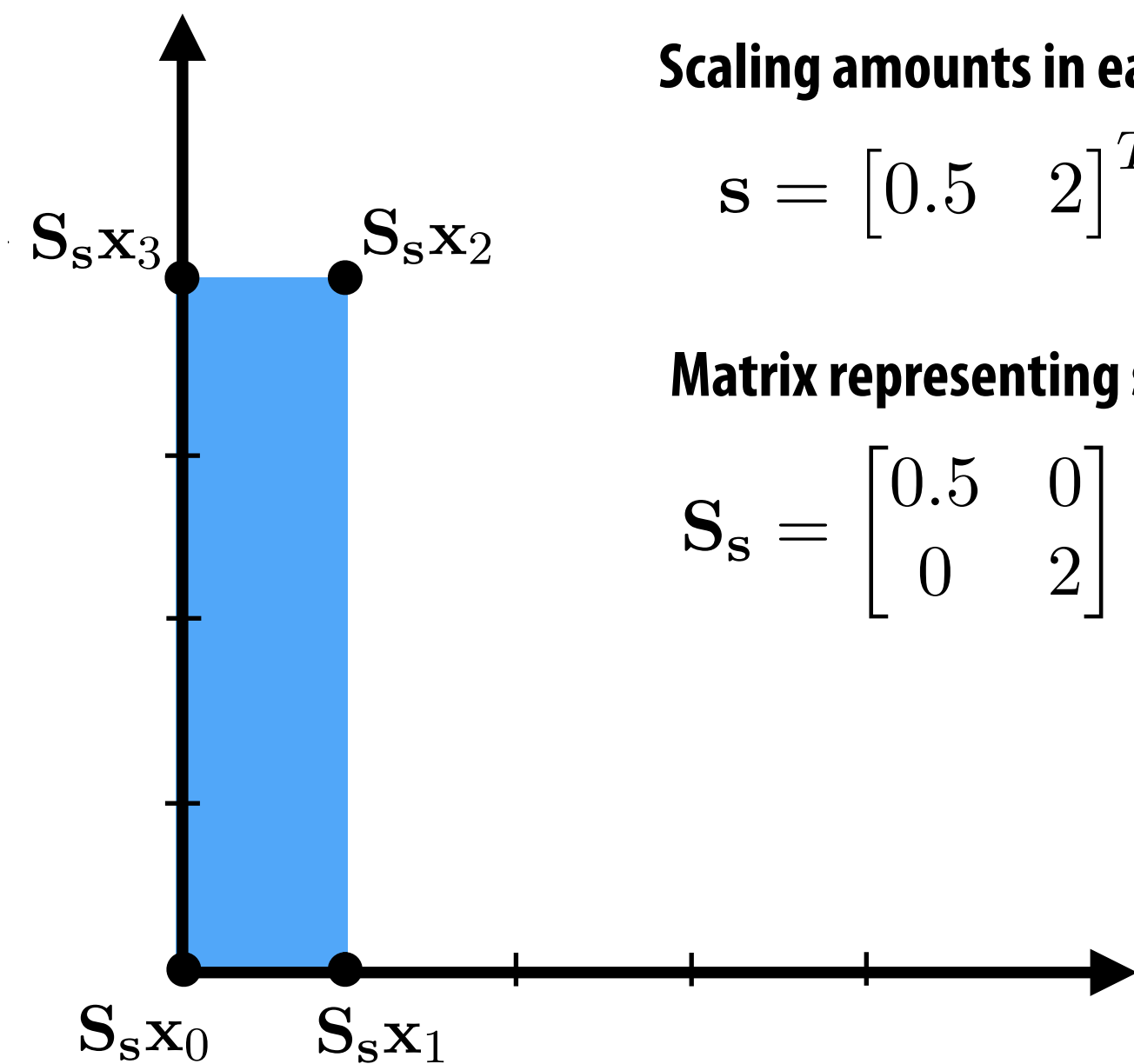
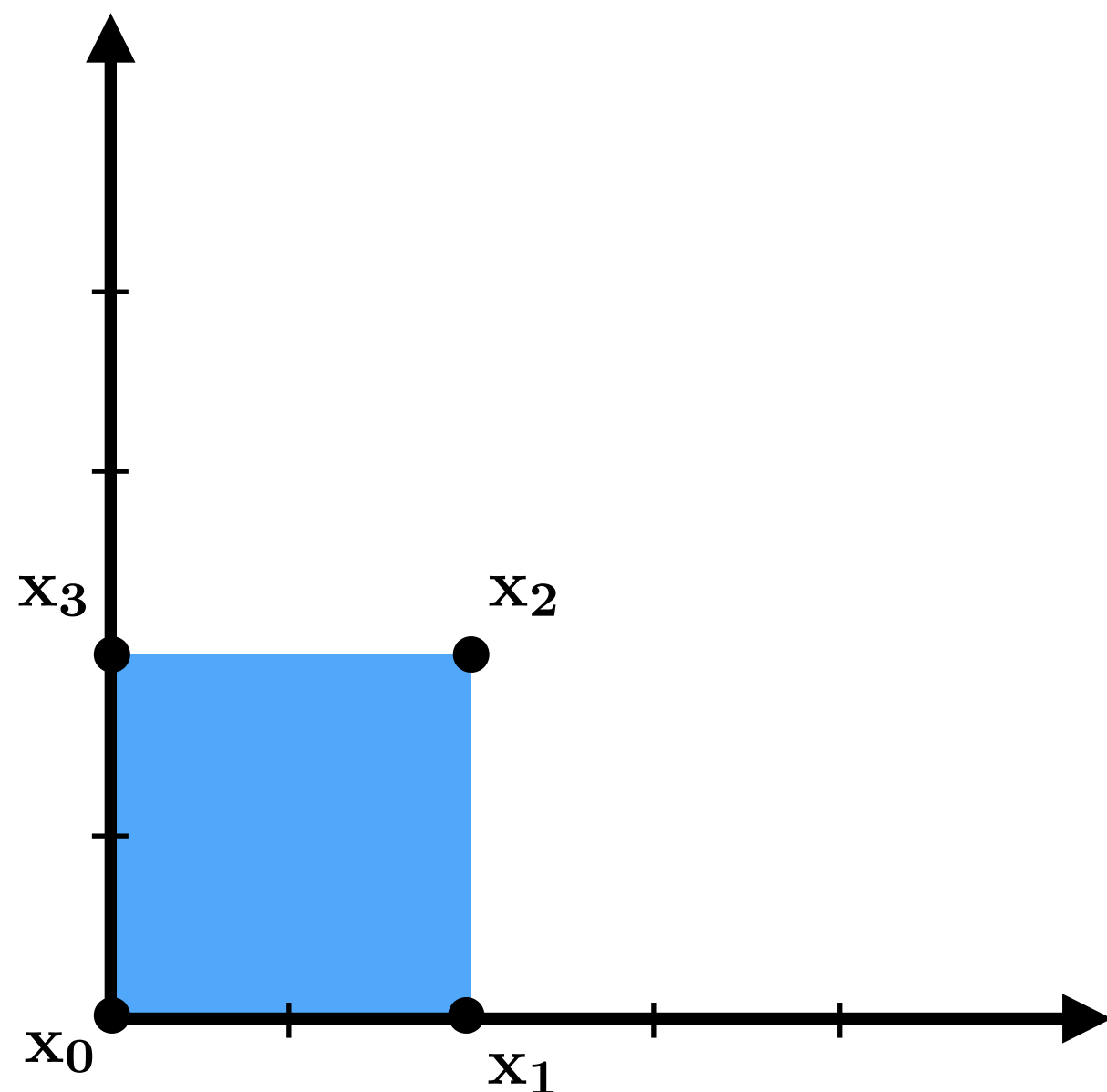

Scaling amounts in each direction:

$$s = [0.5 \quad 2]^T$$

Matrix representing scale transform:

$$S_s = \begin{bmatrix} 0.5 & 0 \\ 0 & 2 \end{bmatrix}$$



# Rotation matrix (2D)

**Question:** what happens to  $(1, 0)$  and  $(0, 1)$  after rotation by  $\theta$ ?

**Reminder:** rotation moves points along circular trajectories.

**(Recall that  $\cos \theta$  and  $\sin \theta$  are the coordinates of a point on the unit circle.)**

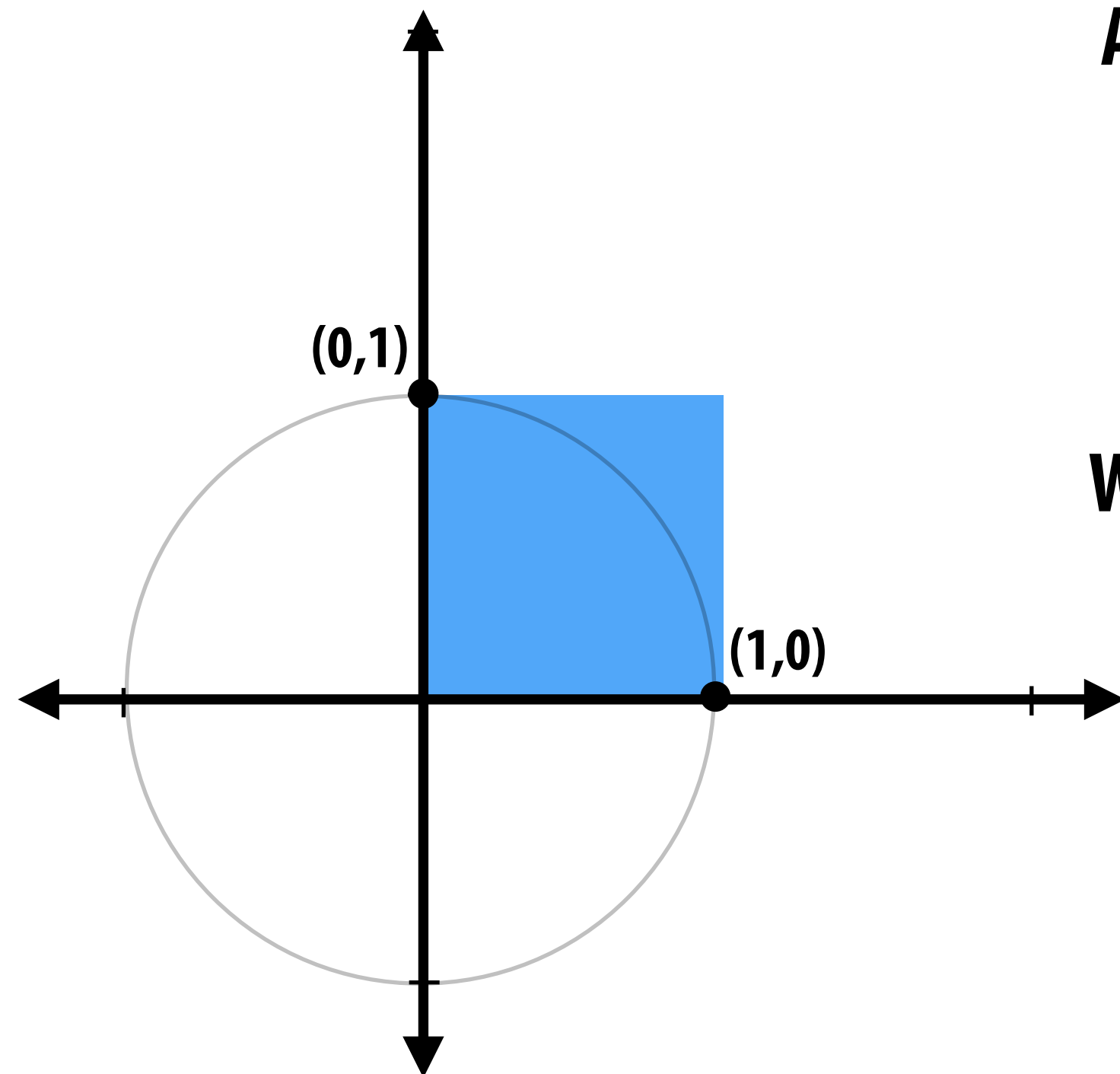

**Answer:**

$$R_{\theta}(1, 0) = (\cos(\theta), \sin(\theta))$$

$$R_{\theta}(0, 1) = (\cos(\theta + \pi/2), \sin(\theta + \pi/2))$$

**Which means the matrix must look like:**

$$R_{\theta} = \begin{bmatrix} \cos(\theta) & \cos(\theta + \pi/2) \\ \sin(\theta) & \sin(\theta + \pi/2) \end{bmatrix}$$

$$= \begin{bmatrix} \cos(\theta) & -\sin(\theta) \\ \sin(\theta) & \cos(\theta) \end{bmatrix}$$

# Rotation matrix (2D): another way...

$$\mathbf{R}_\theta = \begin{bmatrix} \cos \theta & -\sin \theta \\ \sin \theta & \cos \theta \end{bmatrix}$$

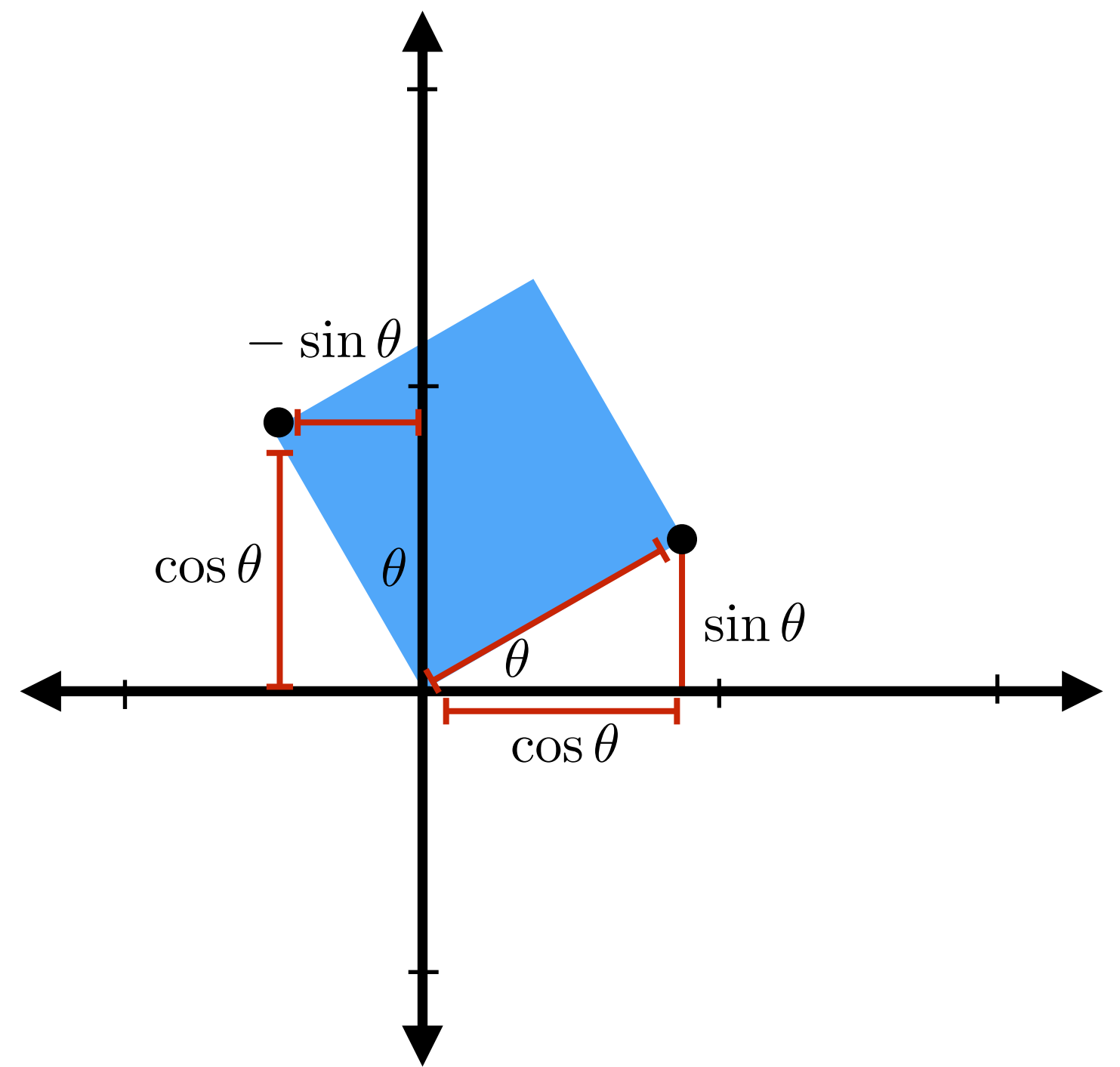
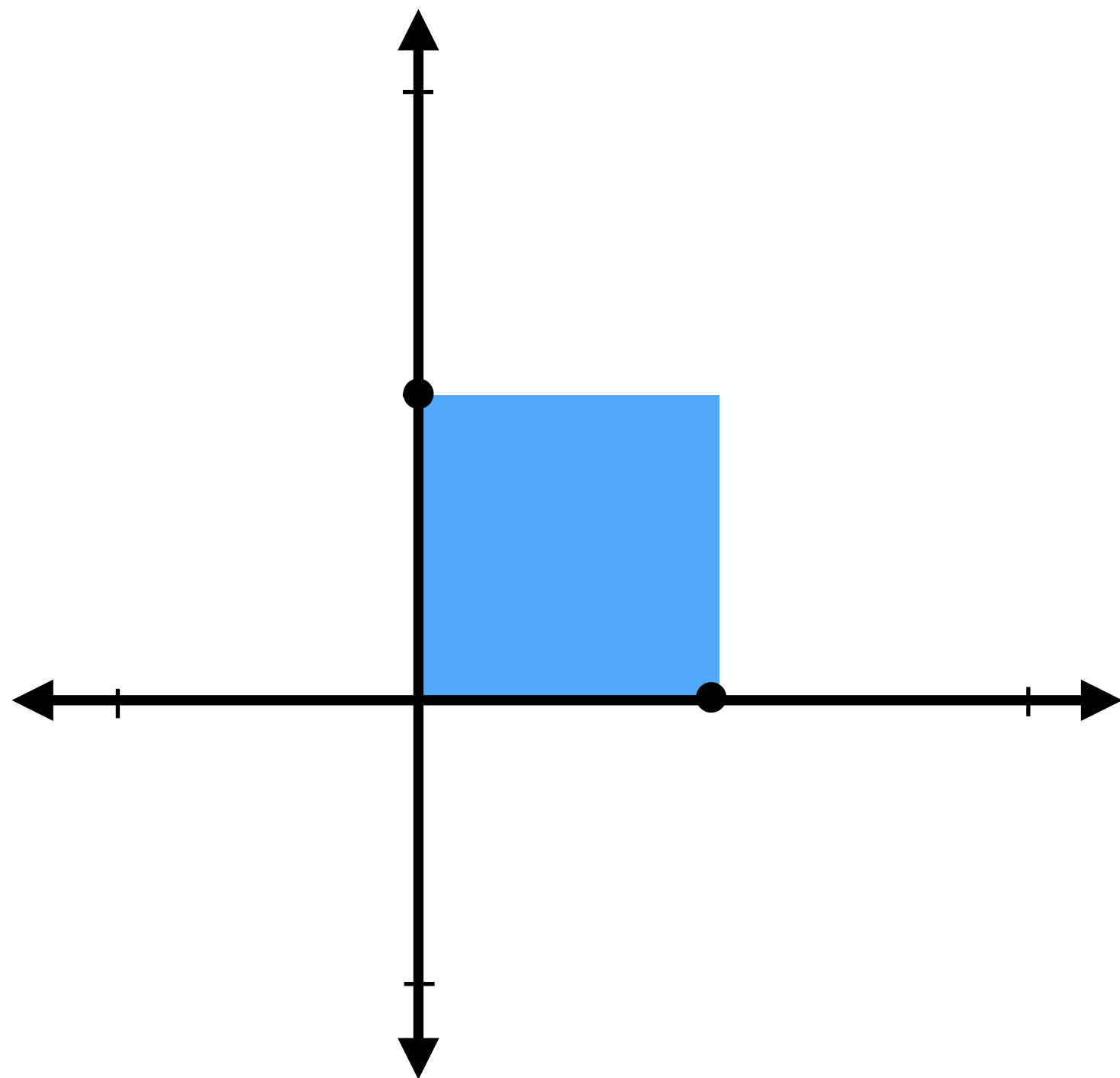

# Shear

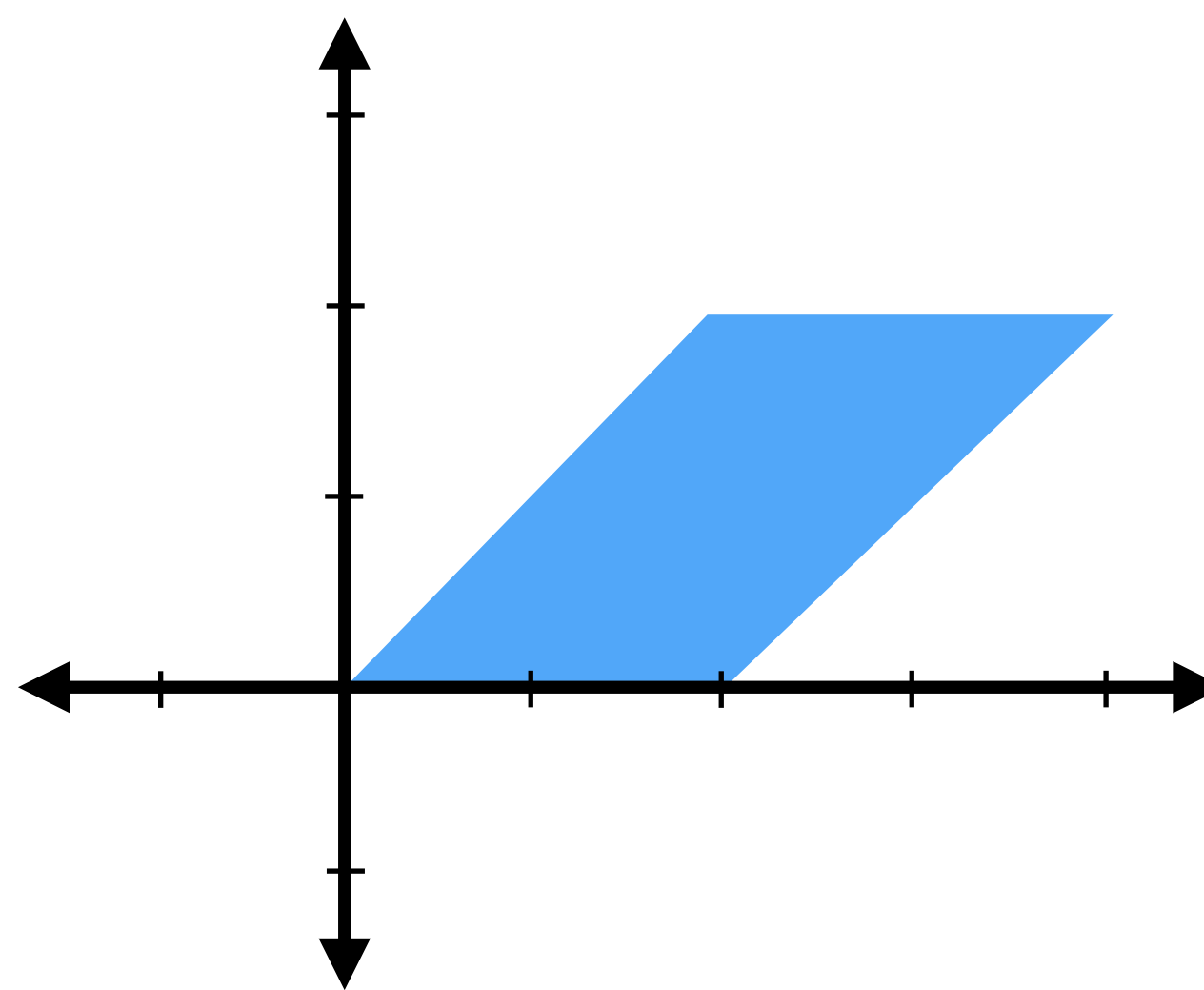
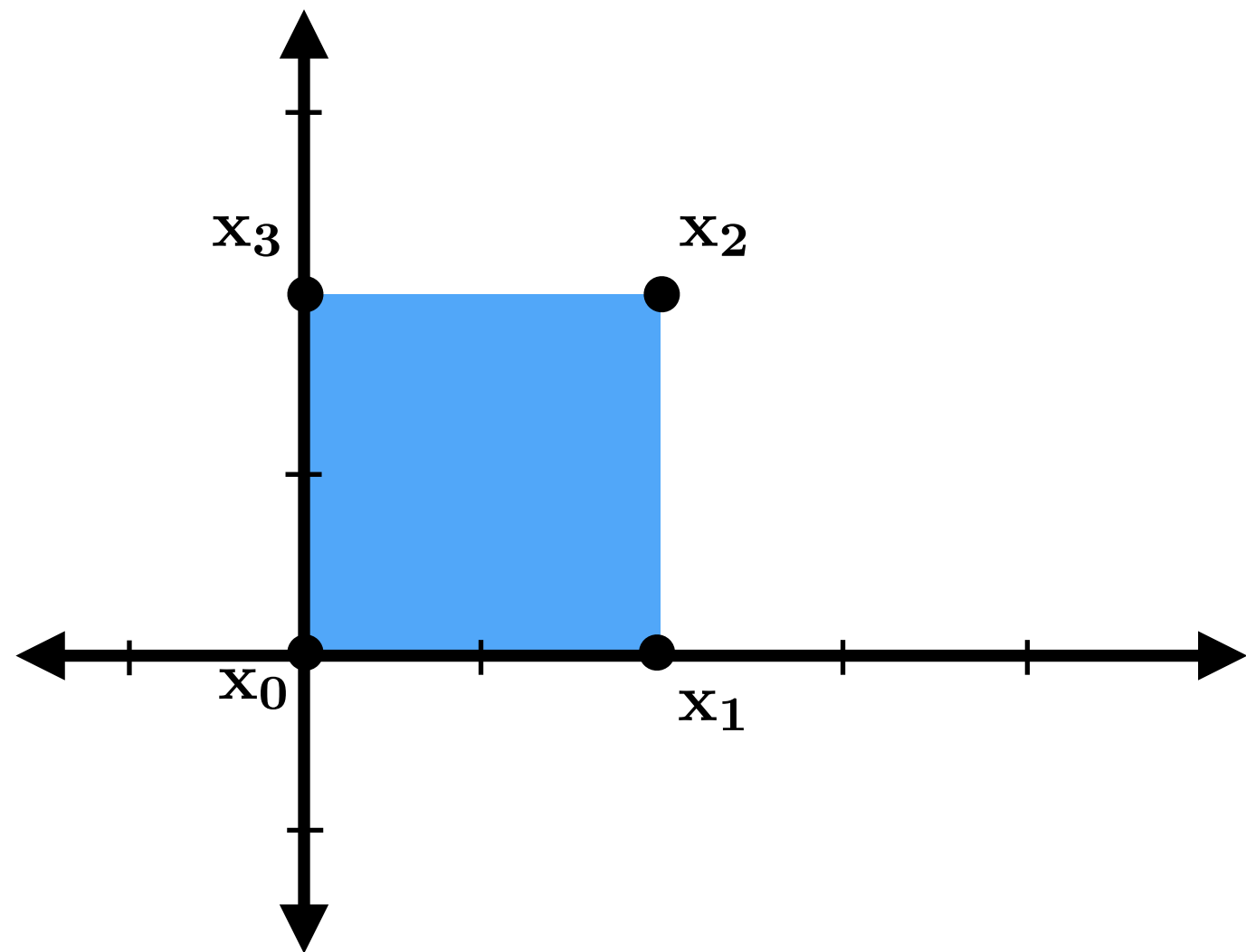

Shear in x:

$$\mathbf{H}_{xs} = \begin{bmatrix} 1 & s \\ 0 & 1 \end{bmatrix}$$

Arbitrary shear:

$$\mathbf{H}_{st} = \begin{bmatrix} 1 & s \\ t & 1 \end{bmatrix}$$

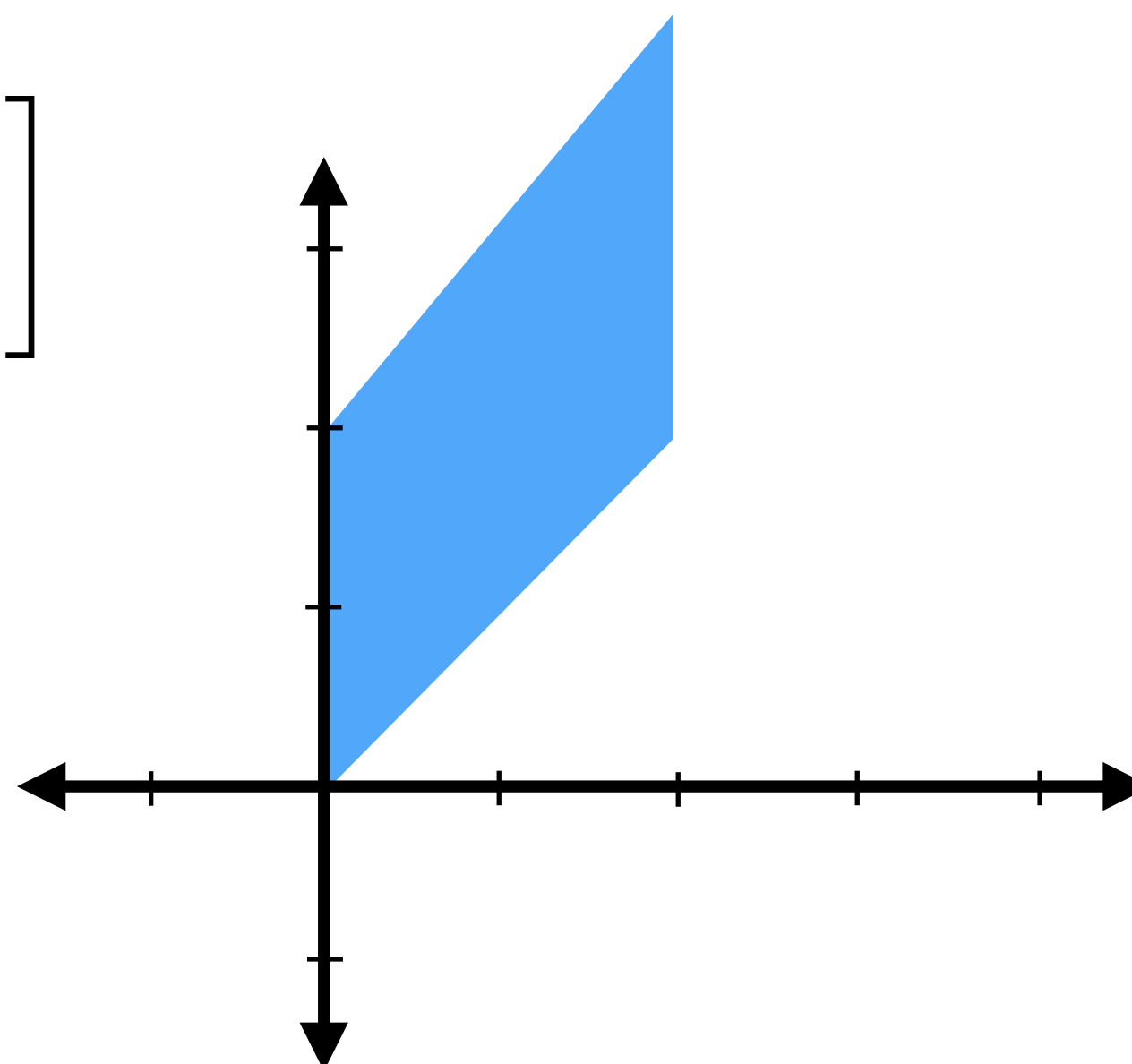
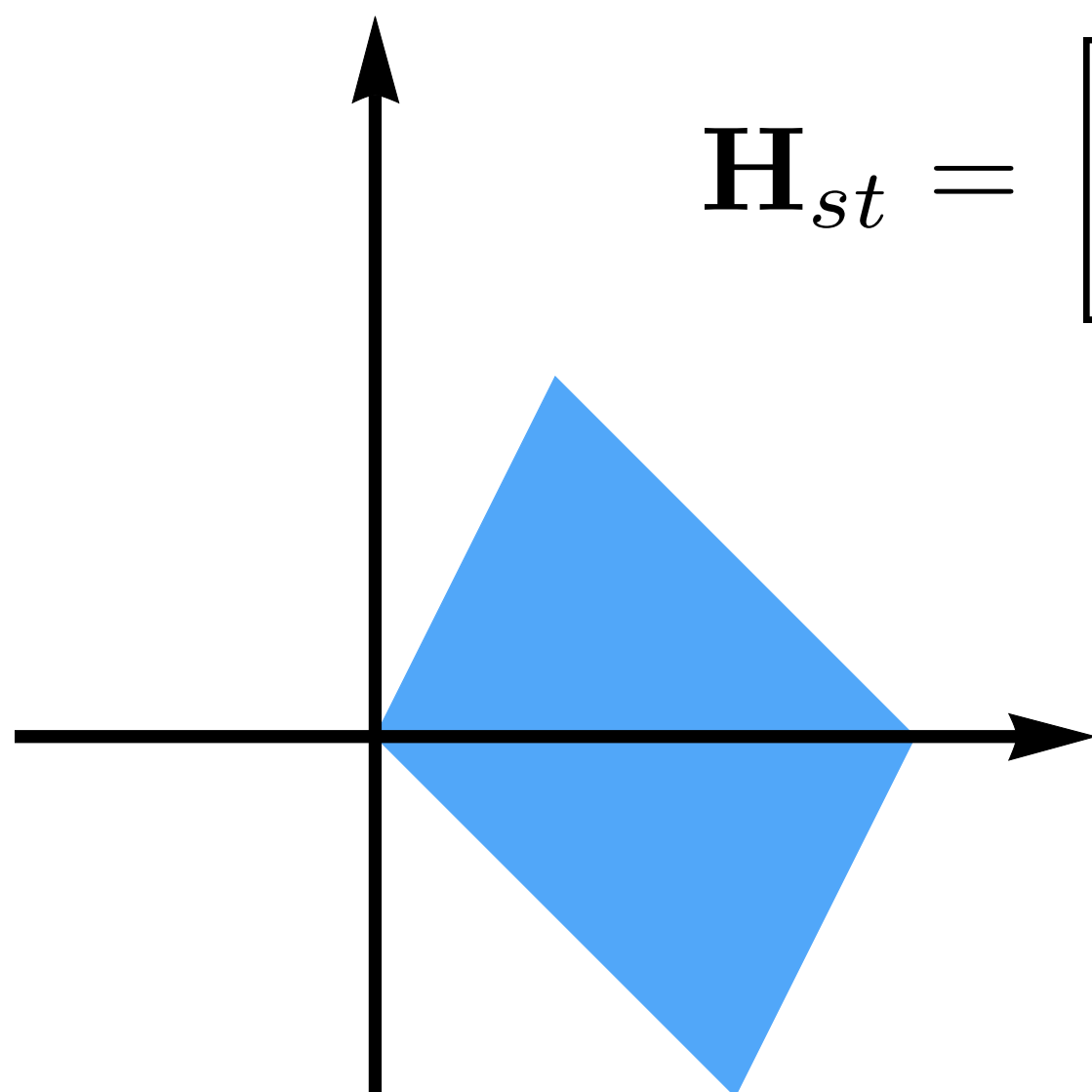

Shear in y:

$$\mathbf{H}_{ys} = \begin{bmatrix} 1 & 0 \\ s & 1 \end{bmatrix}$$

# How do we compose linear transformations?

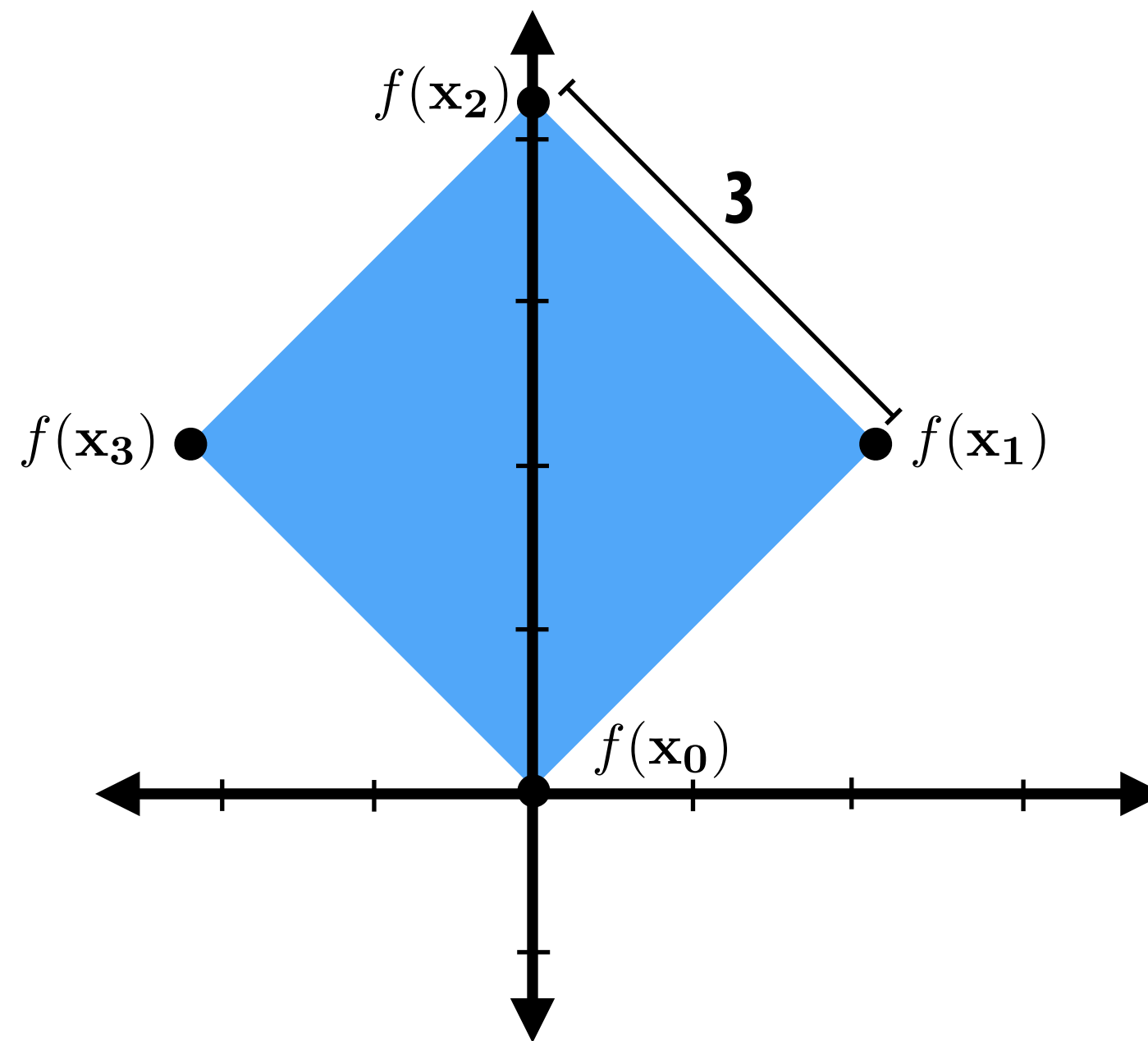
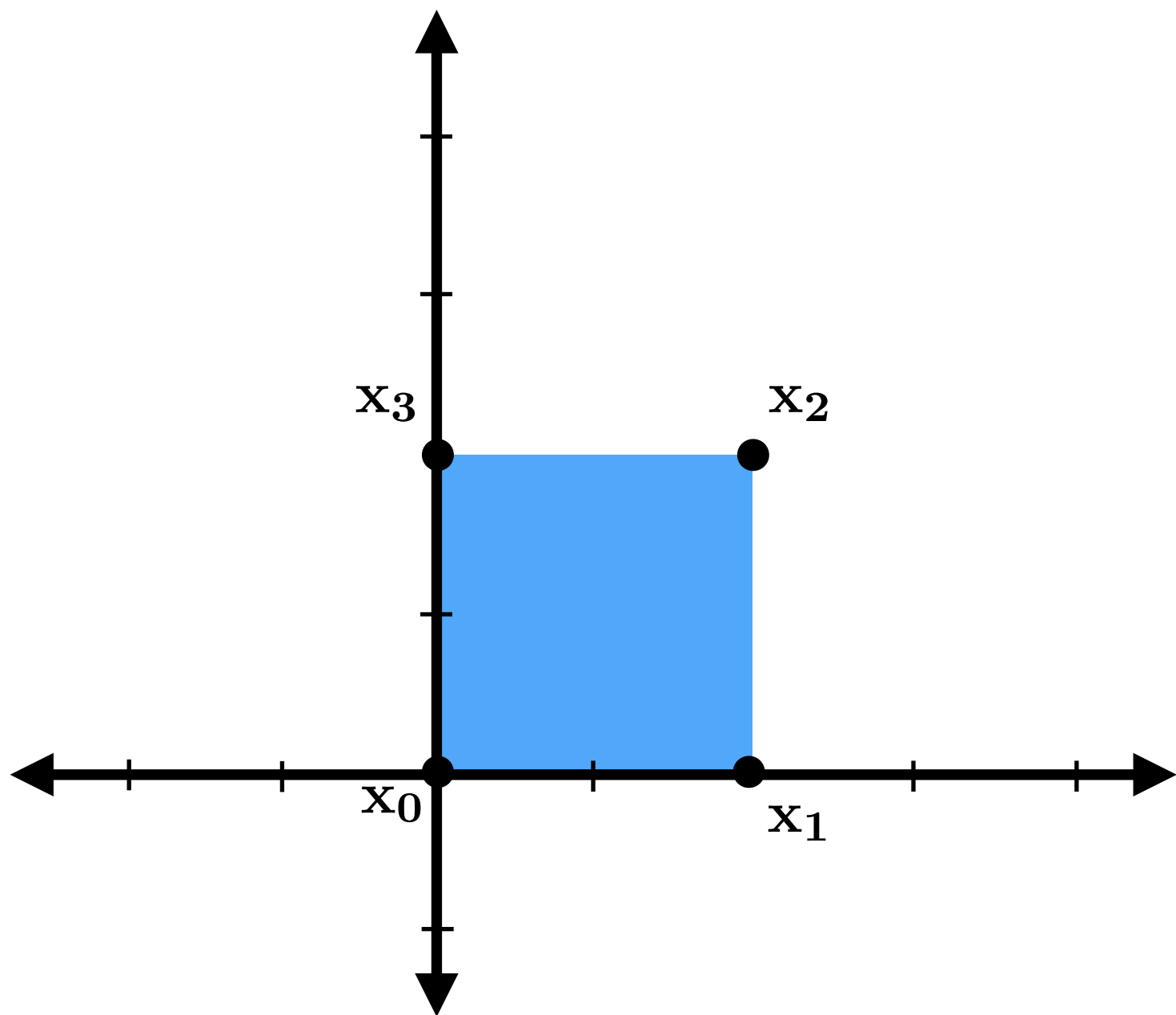

**Compose linear transformations via matrix multiplication.**

**This example: uniform scale, followed by rotation**

$$f(\mathbf{x}) = R_{\pi/4} \mathbf{S}_{[1.5, 1.5]} \mathbf{x}$$

**Enables simple, efficient implementation: reduce complex chain of transformations to a single matrix multiplication.**

# How do we deal with translation? (Not linear)

$$T_{\mathbf{b}}(\mathbf{x}) = \mathbf{x} + \mathbf{b}$$

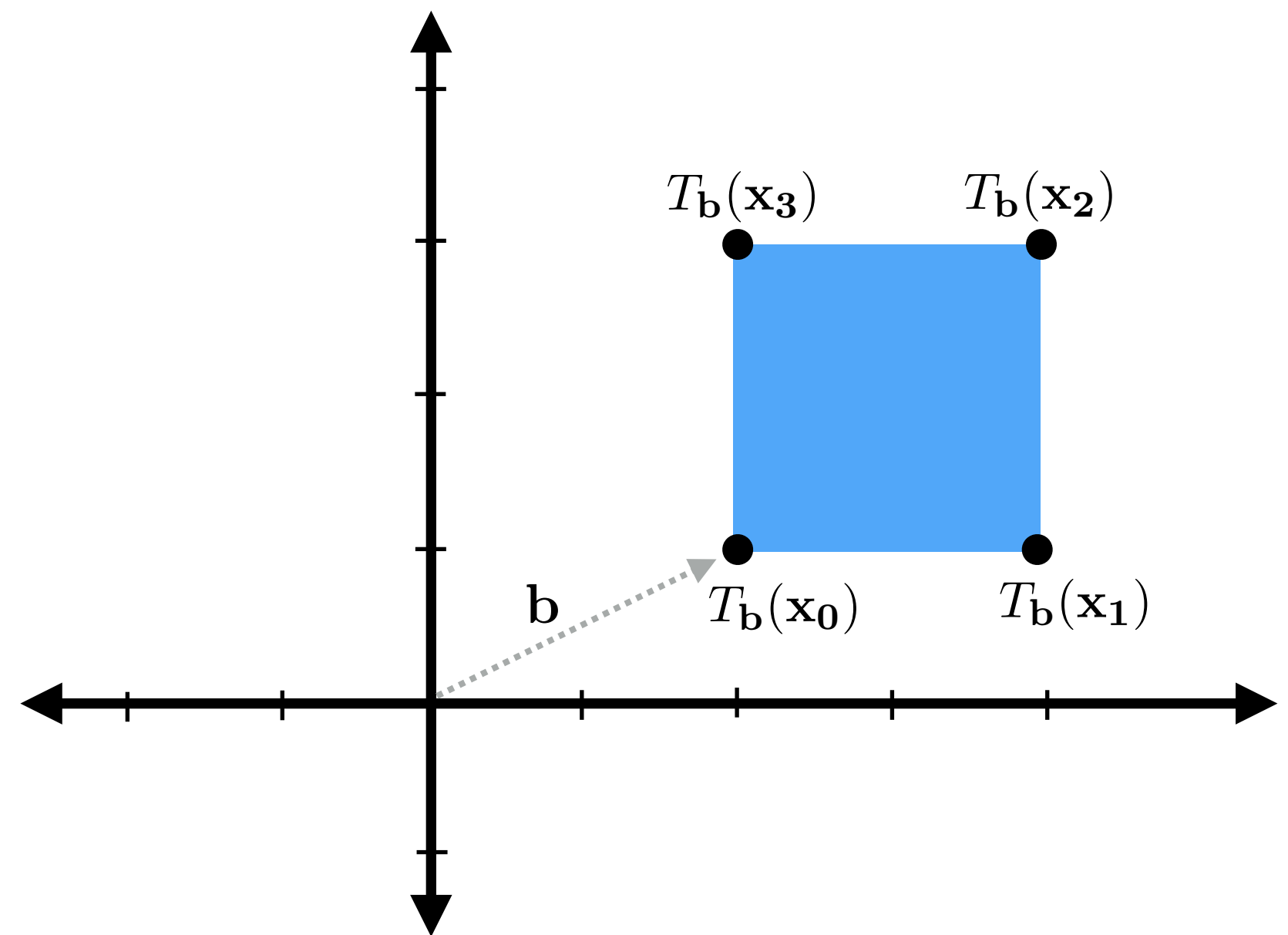
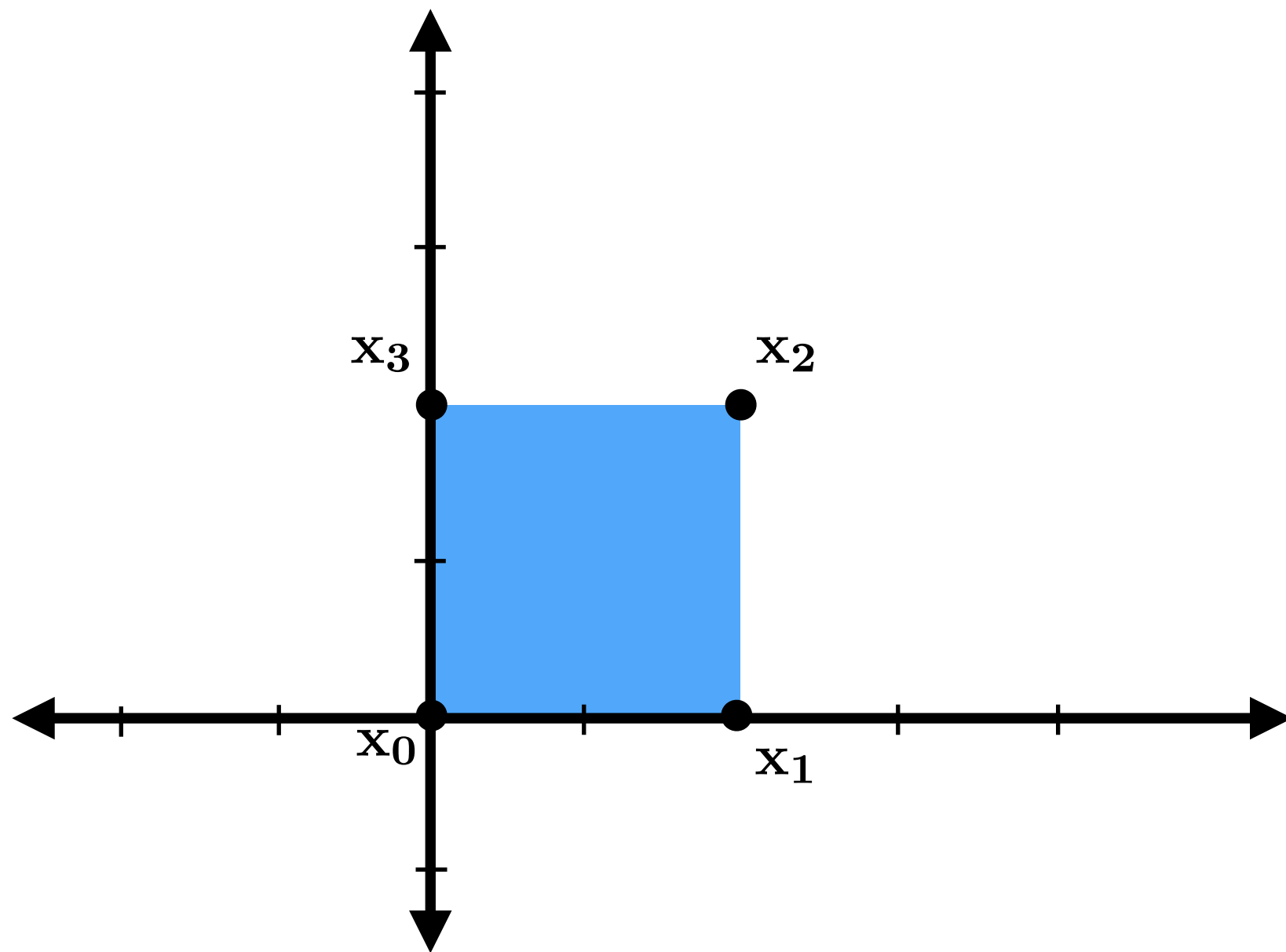

**Recall: translation is not a linear transform**

→ **Output coefficients are not a linear combination of input coefficients**

→ **Translation operation cannot be represented by a 2x2 matrix**

$$\mathbf{x}_{\text{out}x} = \mathbf{x}_x + \mathbf{b}_x$$

$$\mathbf{x}_{\text{out}y} = \mathbf{x}_y + \mathbf{b}_y$$

**Translation math**

# 2D homogeneous coordinates (2D-H)

Idea: represent 2D points with THREE values (“homogeneous coordinates”)

So the point  $(x, y)$  is represented as the 3-vector:  $[x \quad y \quad 1]^T$

And transformations are represented a 3x3 matrices that transform these vectors.

Recover final 2D coordinates by dividing by “extra” (third) coordinate

$$\begin{bmatrix} x \\ y \\ w \end{bmatrix} \Rightarrow \begin{bmatrix} x/w \\ y/w \end{bmatrix}$$

(More on this later...)

# Example: scale and rotation in 2D-H coords

- For transformations that are already linear, not much changes:

$$\mathbf{S}_s = \begin{bmatrix} \mathbf{S}_x & 0 & 0 \\ 0 & \mathbf{S}_y & 0 \\ 0 & 0 & 1 \end{bmatrix} \quad \mathbf{R}_\theta = \begin{bmatrix} \cos \theta & -\sin \theta & 0 \\ \sin \theta & \cos \theta & 0 \\ 0 & 0 & 1 \end{bmatrix}$$

Notice that the last row/column doesn't do anything interesting. E.g., for scaling:

$$\mathbf{S}_s \begin{bmatrix} x \\ y \\ 1 \end{bmatrix} = \begin{bmatrix} \mathbf{S}_x x \\ \mathbf{S}_y y \\ 1 \end{bmatrix}$$

Now we divide by the 3rd coordinate to get our final 2D coordinates (not too exciting!)

$$\begin{bmatrix} \mathbf{S}_x x \\ \mathbf{S}_y y \\ 1 \end{bmatrix} \Rightarrow \begin{bmatrix} \mathbf{S}_x x / 1 \\ \mathbf{S}_y y / 1 \end{bmatrix} = \begin{bmatrix} \mathbf{S}_x x \\ \mathbf{S}_y y \end{bmatrix}$$

(Will get more interesting when we talk about *perspective*...)

# Translation in 2D homogeneous coordinates

Translation expressed as 3x3 matrix multiplication:

$$\mathbf{T}_b = \begin{bmatrix} 1 & 0 & \mathbf{b}_x \\ 0 & 1 & \mathbf{b}_y \\ 0 & 0 & 1 \end{bmatrix}$$

$$\mathbf{T}_b \mathbf{x} = \begin{bmatrix} 1 & 0 & \mathbf{b}_x \\ 0 & 1 & \mathbf{b}_y \\ 0 & 0 & 1 \end{bmatrix} \begin{bmatrix} \mathbf{x}_x \\ \mathbf{x}_y \\ 1 \end{bmatrix} = \begin{bmatrix} \mathbf{x}_x + \mathbf{b}_x \\ \mathbf{x}_y + \mathbf{b}_y \\ 1 \end{bmatrix} \quad \text{(remember: just a linear combination of columns!)}$$

**Cool:** homogeneous coordinates let us encode translations as *linear* transformations!



# Homogeneous coordinates: some intuition

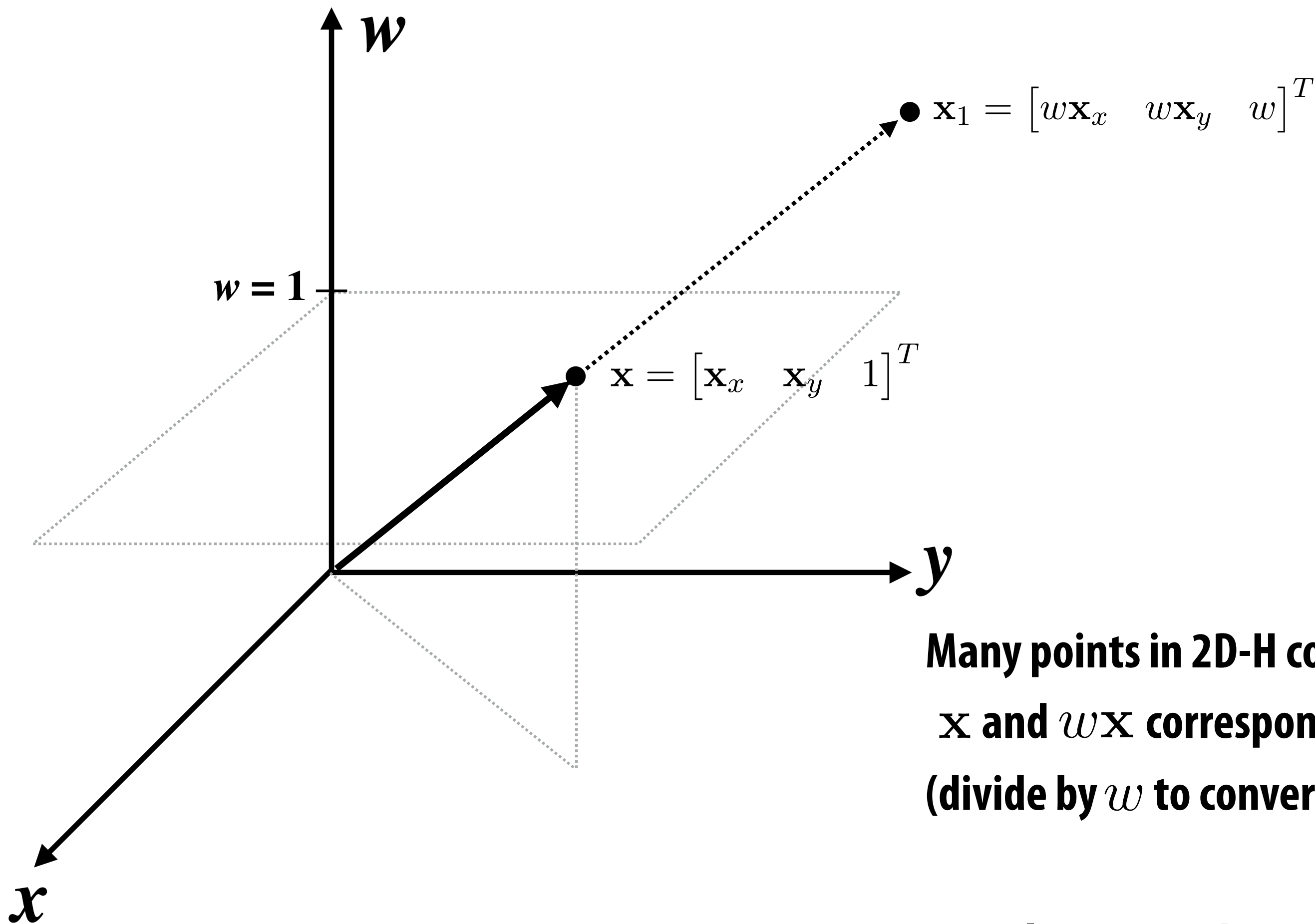

**Many points in 2D-H correspond to same point in 2D**  
 $\mathbf{x}$  and  $w\mathbf{x}$  correspond to the same 2D point  
(divide by  $w$  to convert 2D-H back to 2D)

**Translation is a shear in  $x$  and  $y$  in 2D-H space**

$$\mathbf{T}_{\mathbf{b}}\mathbf{x} = \begin{bmatrix} 1 & 0 & \mathbf{b}_x \\ 0 & 1 & \mathbf{b}_y \\ 0 & 0 & 1 \end{bmatrix} \begin{bmatrix} w\mathbf{x}_x \\ w\mathbf{x}_y \\ w \end{bmatrix} = \begin{bmatrix} w\mathbf{x}_x + w\mathbf{b}_x \\ w\mathbf{x}_y + w\mathbf{b}_y \\ w \end{bmatrix}$$

# Translation = shear in homogeneous space

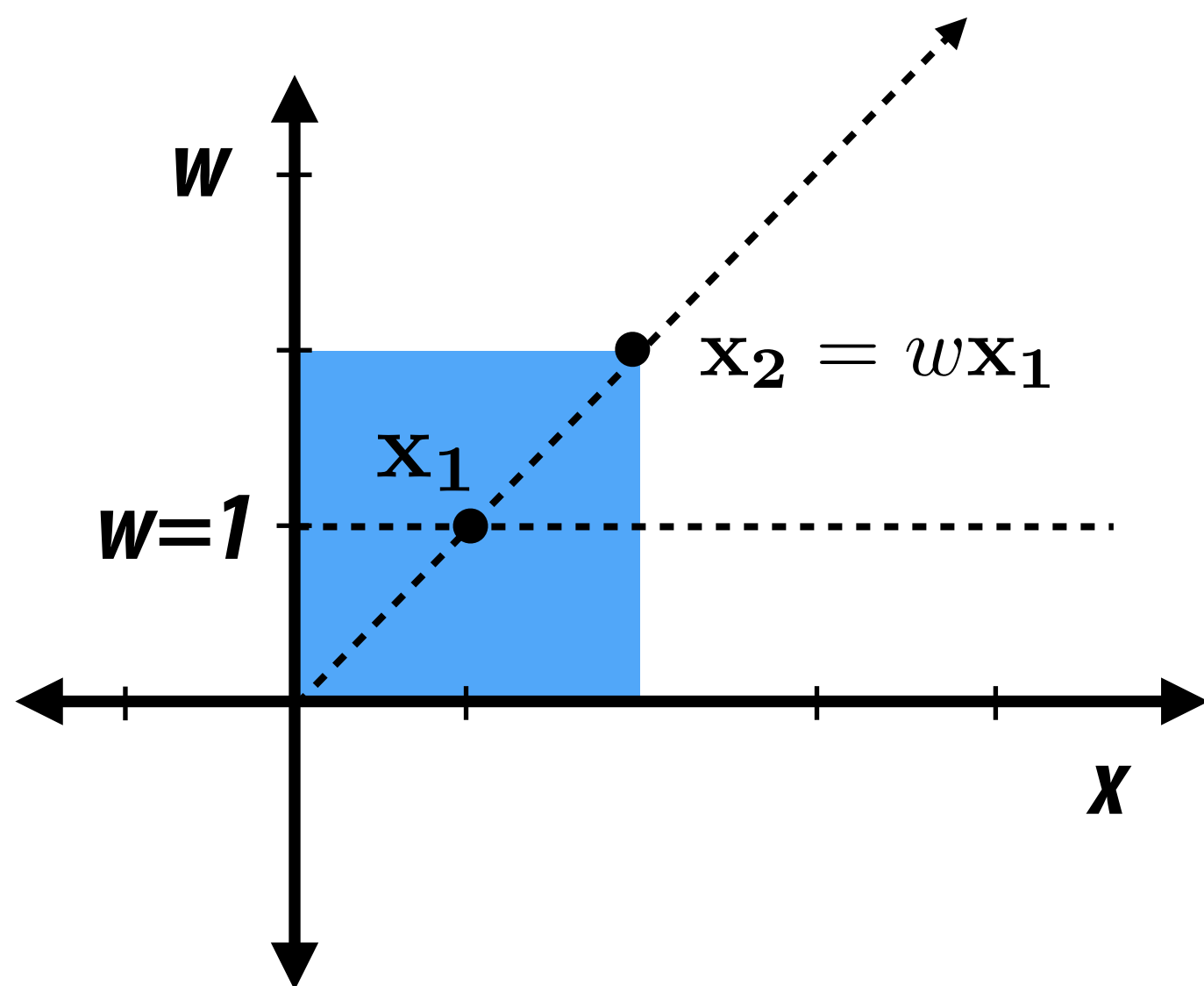

For simplicity, consider 1D-H:

$$\text{Translate by } t=2: \quad \mathbf{T} = \begin{bmatrix} 1 & t \\ 0 & 1 \end{bmatrix} = \begin{bmatrix} 1 & 2 \\ 0 & 1 \end{bmatrix}$$

Recall: this is a shear in homogeneous  $x$ .

1D translation is affine in 1D ( $x + t$ ),  
but it is linear in 1D-H

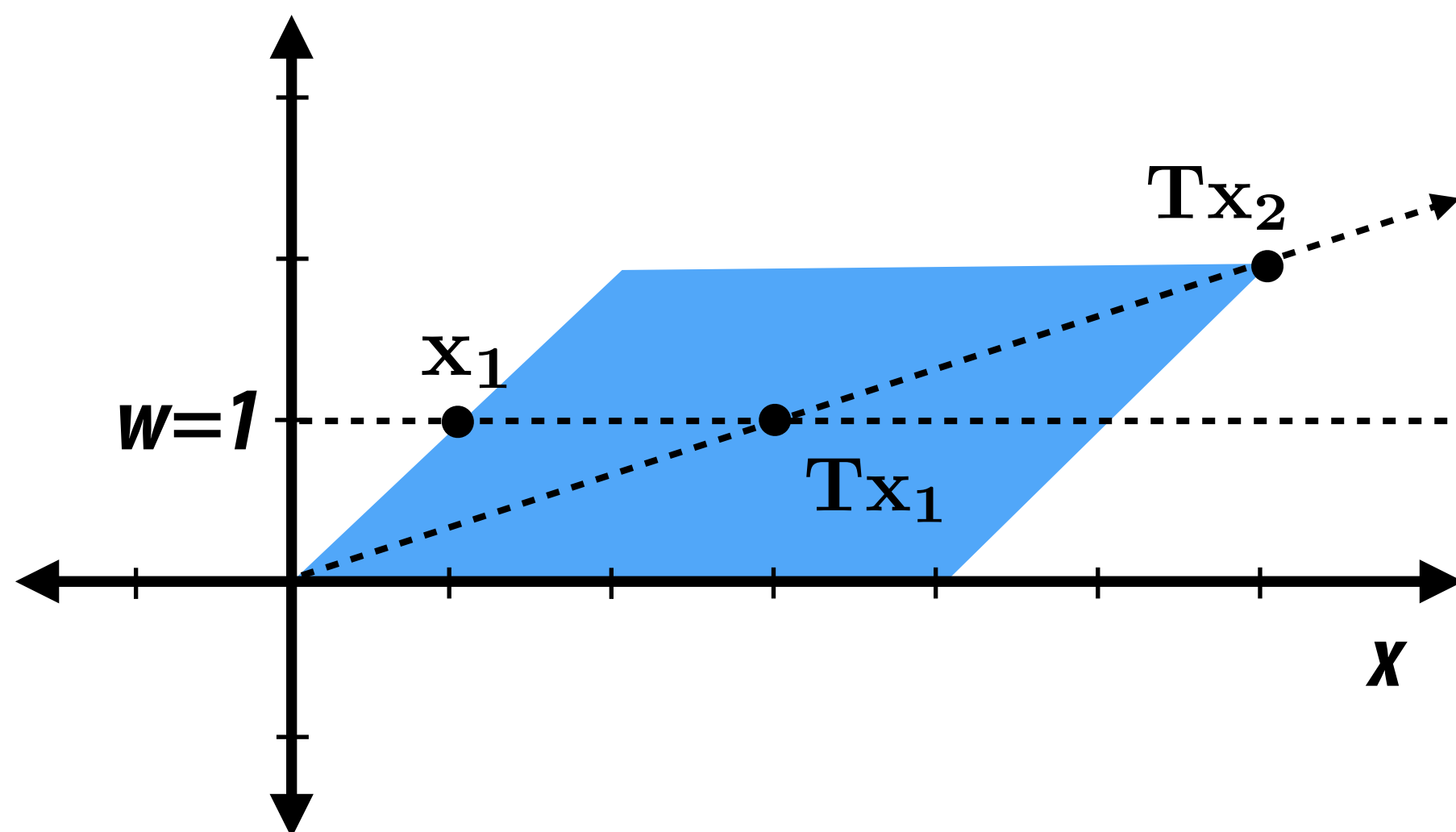

# Homogeneous coordinates: points vs. vectors

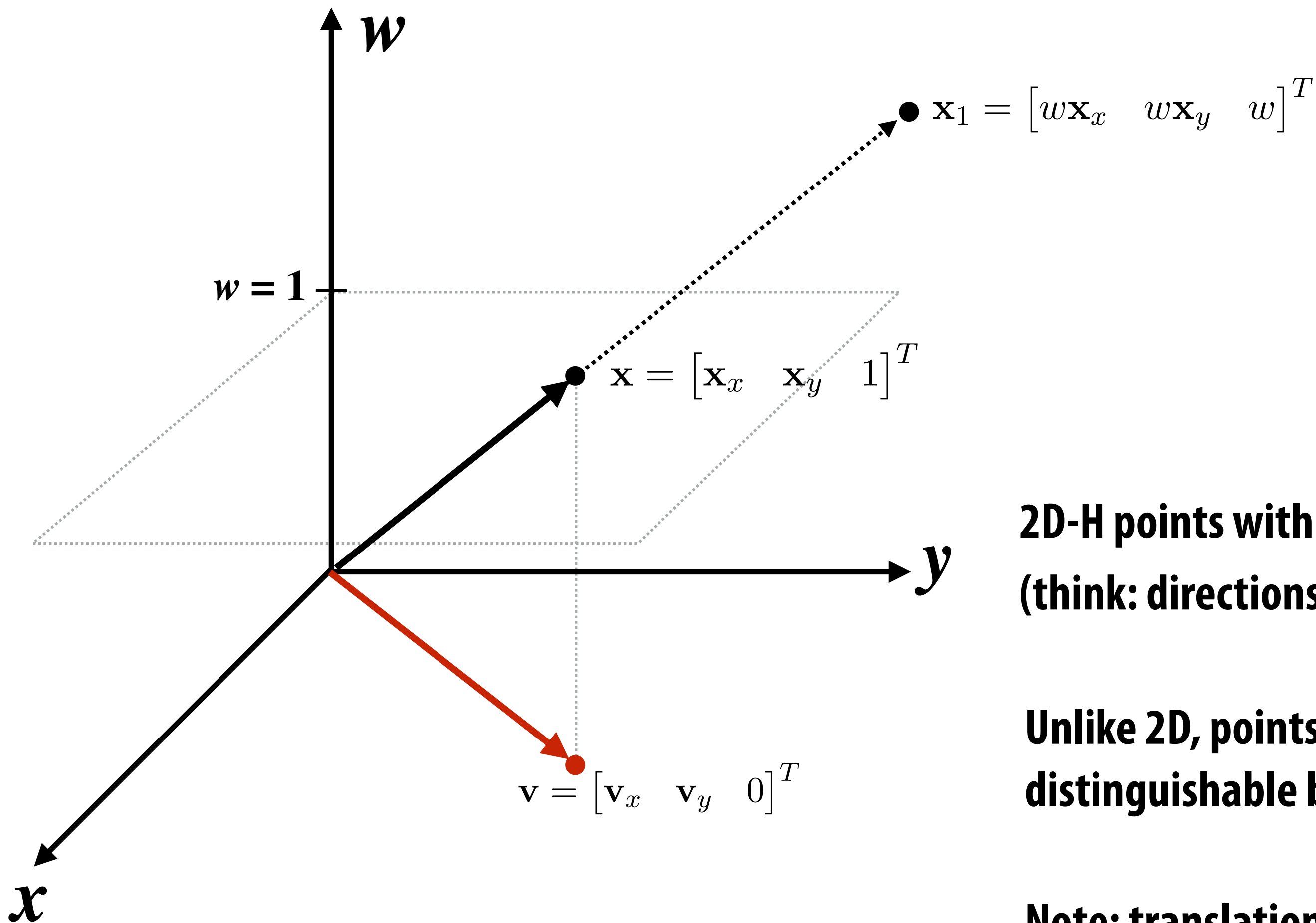

**2D-H points with  $w=0$  represent 2D vectors  
(think: directions are points at infinity)**

**Unlike 2D, points and directions are  
distinguishable by their representation in 2D-H**

**Note: translation does not modify directions:**

$$\mathbf{T}_{\mathbf{b}} \mathbf{v} = \begin{bmatrix} 1 & 0 & \mathbf{b}_x \\ 0 & 1 & \mathbf{b}_y \\ 0 & 0 & 1 \end{bmatrix} \begin{bmatrix} \mathbf{v}_x \\ \mathbf{v}_y \\ 0 \end{bmatrix} = \begin{bmatrix} \mathbf{v}_x \\ \mathbf{v}_y \\ 0 \end{bmatrix}$$

# Visualizing 2D transformations in 2D-H

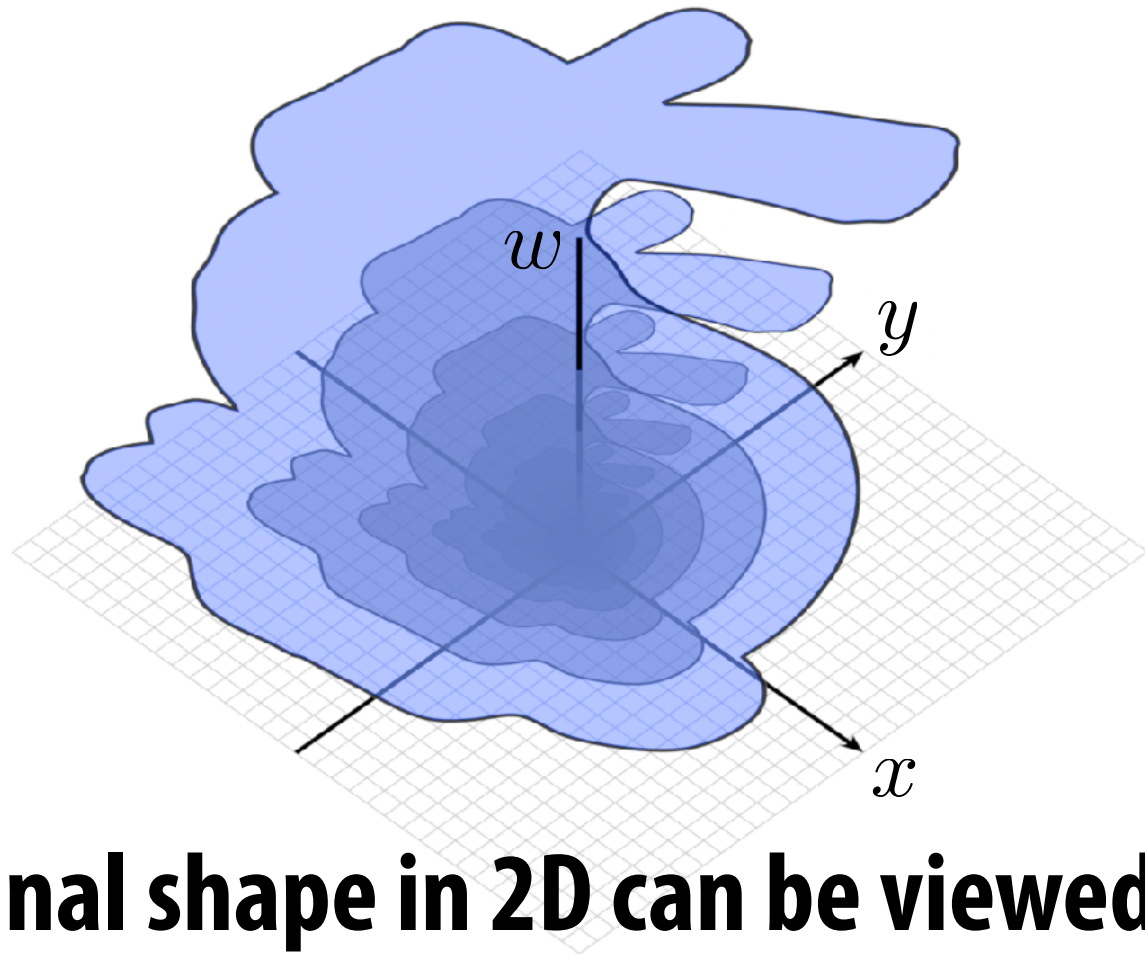

Original shape in 2D can be viewed as many copies, uniformly scaled by  $w$ .

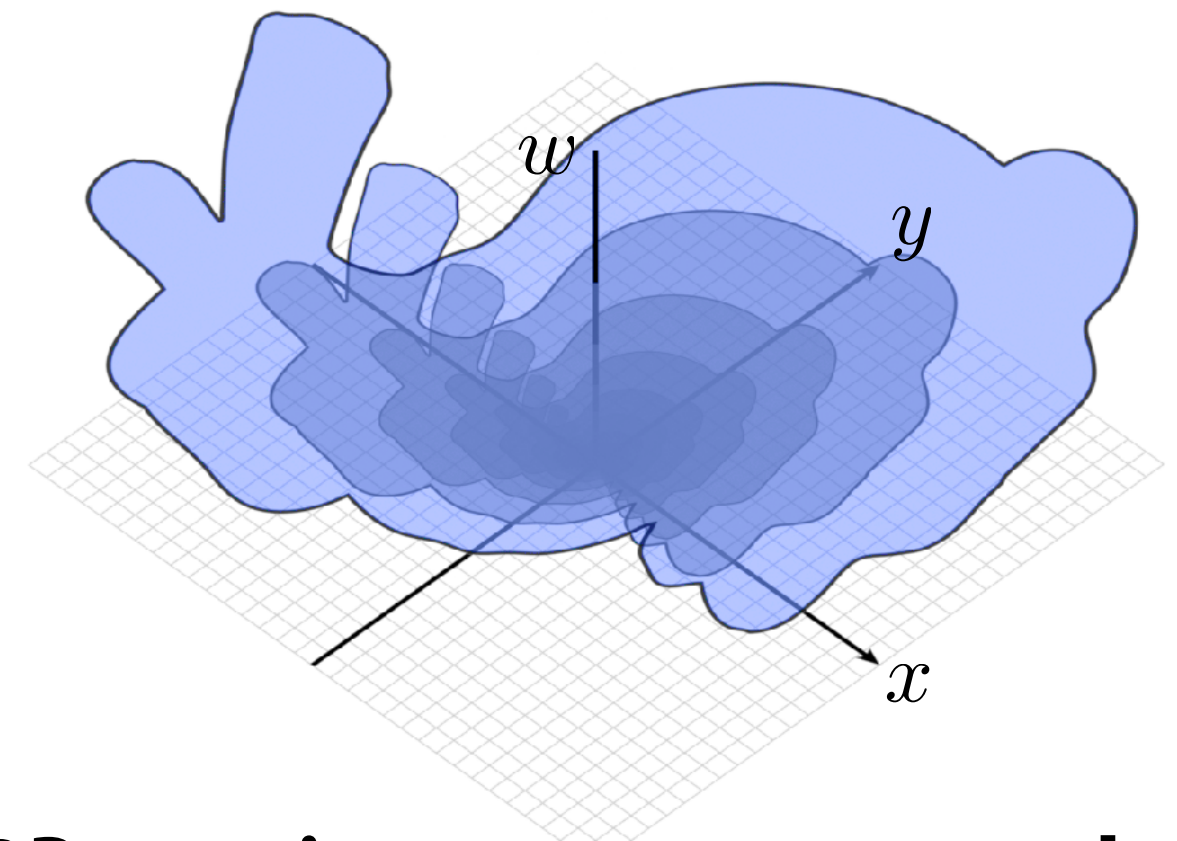

2D rotation  $\leftrightarrow$  rotate around  $w$

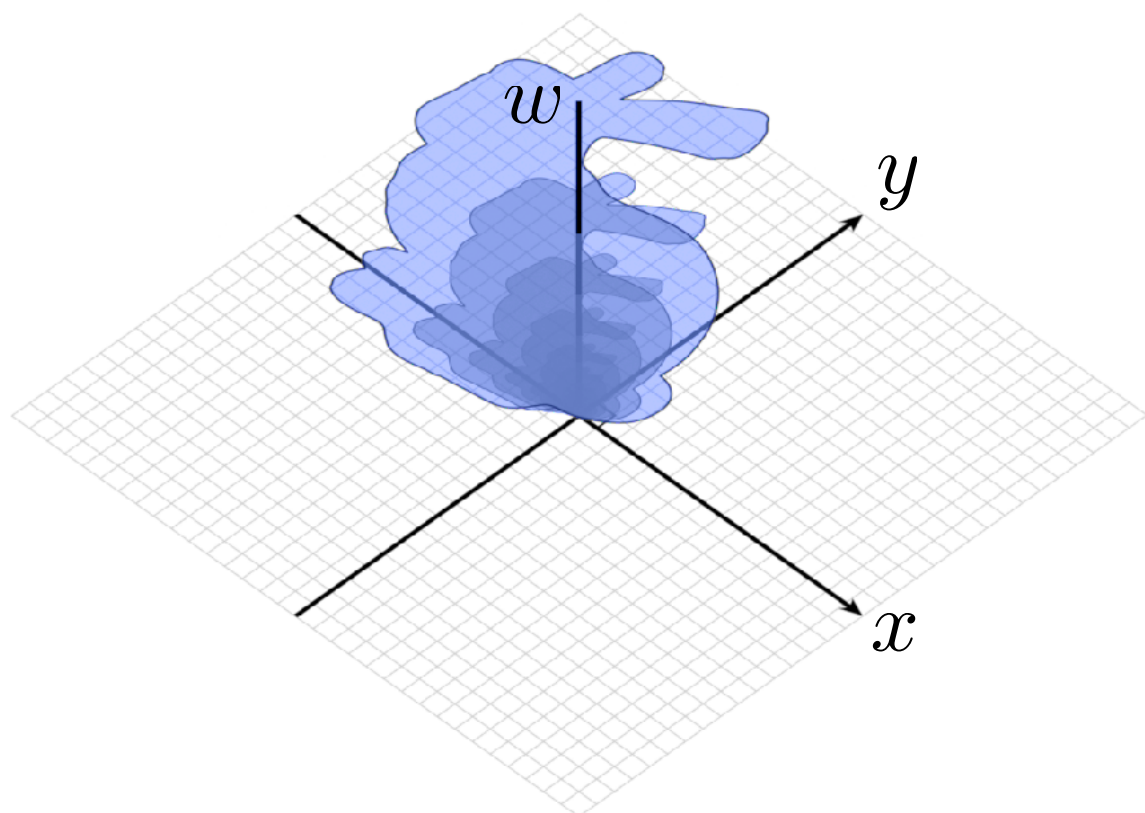

2D scale  $\leftrightarrow$  scale  $x$  and  $y$ ; preserve  $w$   
(Question: what happens to 2D shape if you scale  $x$ ,  $y$ , and  $w$  uniformly?)

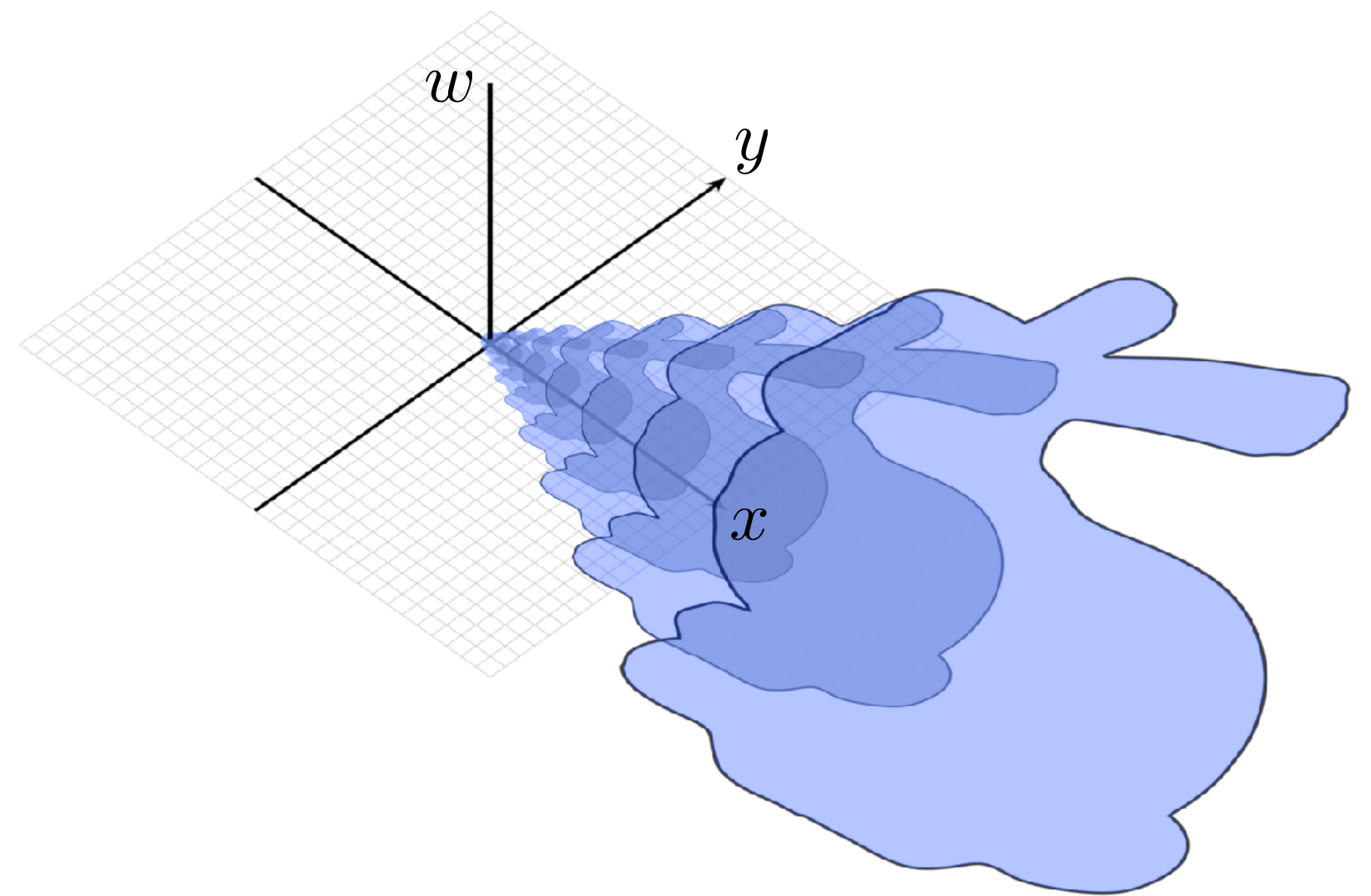

2D translate  $\leftrightarrow$  shear in 2D-H  
**(LINEAR!)**

# Moving to 3D (and 3D-H)

Represent 3D transformations as 3x3 matrices and 3D-H transformations as 4x4 matrices

**Scale:**

$$\begin{array}{c} \mathbf{S}_s \\ \text{3D} \end{array} = \begin{bmatrix} \mathbf{S}_x & 0 & 0 \\ 0 & \mathbf{S}_y & 0 \\ 0 & 0 & \mathbf{S}_z \end{bmatrix} \quad \begin{array}{c} \mathbf{S}_s \\ \text{3D-H} \end{array} = \begin{bmatrix} \mathbf{S}_x & 0 & 0 & 0 \\ 0 & \mathbf{S}_y & 0 & 0 \\ 0 & 0 & \mathbf{S}_z & 0 \\ 0 & 0 & 0 & 1 \end{bmatrix}$$

**Shear (in x, based on y,z position):**

$$\mathbf{H}_{x,d} = \begin{bmatrix} 1 & \mathbf{d}_y & \mathbf{d}_z \\ 0 & 1 & 0 \\ 0 & 0 & 1 \end{bmatrix} \quad \mathbf{H}_{x,d} = \begin{bmatrix} 1 & \mathbf{d}_y & \mathbf{d}_z & 0 \\ 0 & 1 & 0 & 0 \\ 0 & 0 & 1 & 0 \\ 0 & 0 & 0 & 1 \end{bmatrix}$$

**Translate:**

$$\mathbf{T}_b = \begin{array}{c} \text{3D-H} \\ \begin{bmatrix} 1 & 0 & 0 & \mathbf{b}_x \\ 0 & 1 & 0 & \mathbf{b}_y \\ 0 & 0 & 1 & \mathbf{b}_z \\ 0 & 0 & 0 & 1 \end{bmatrix} \end{array}$$



# Commutativity of rotations—2D

- In 2D, order of rotations doesn't matter:

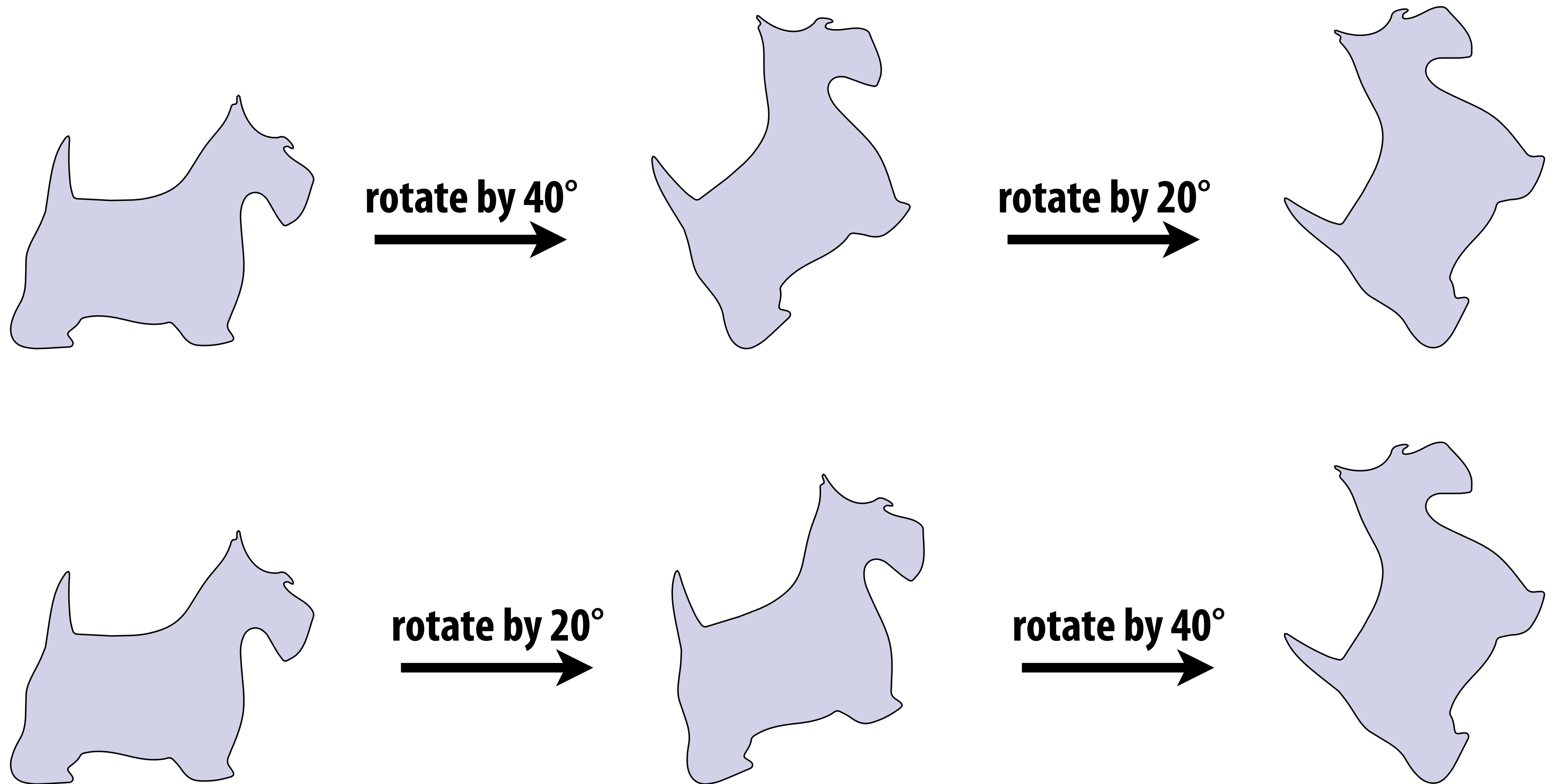

**Same result! ("2D rotations commute")**



# Commutativity of rotations—3D

- What about in 3D?
- IN-CLASS ACTIVITY:
  - Rotate  $90^\circ$  around Y, then  $90^\circ$  around Z, then  $90^\circ$  around X
  - Rotate  $90^\circ$  around Z, then  $90^\circ$  around Y, then  $90^\circ$  around X
  - (Was there any difference?)

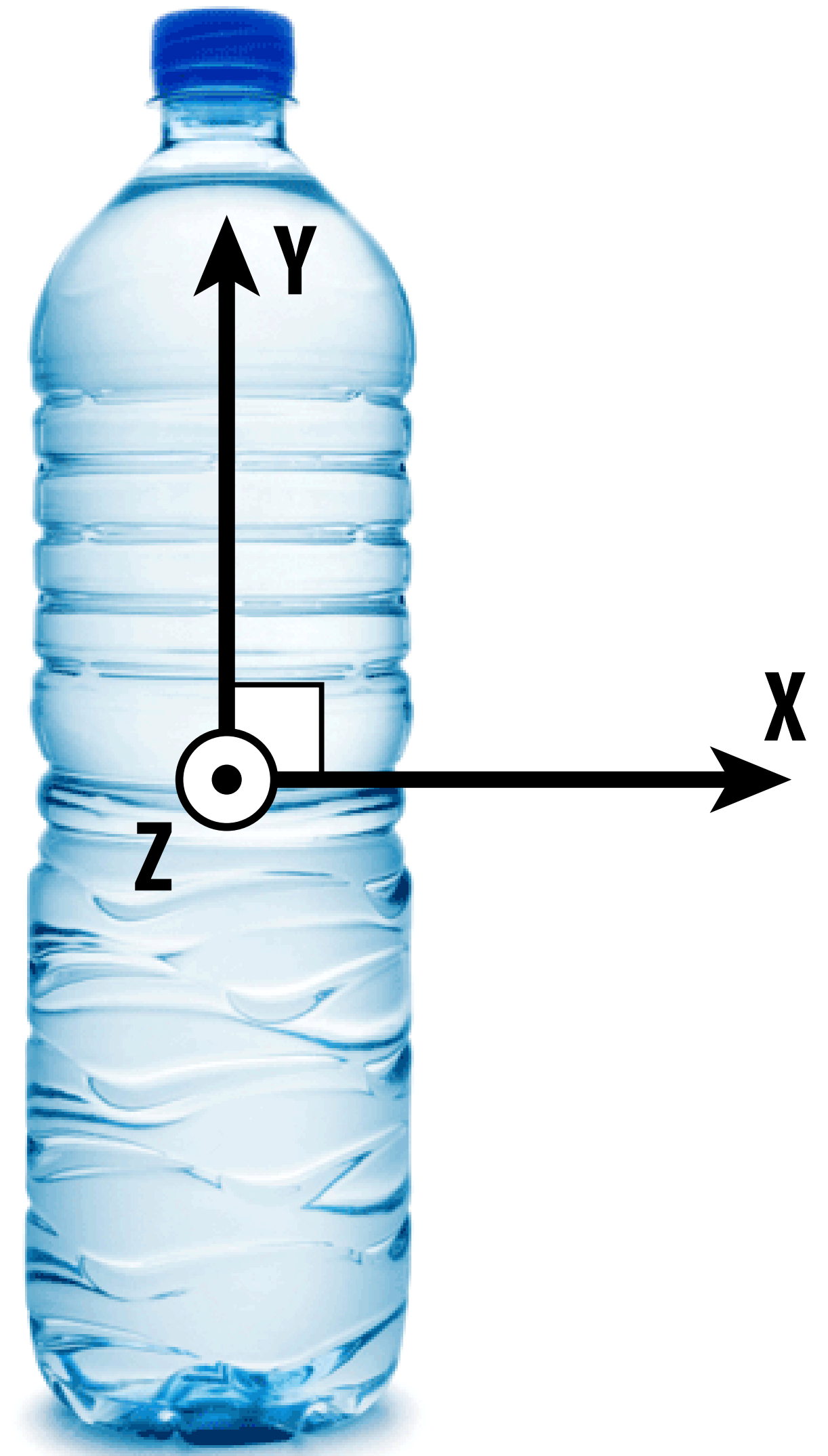

**CONCLUSION: bad things can happen if we're not careful about the order in which we apply rotations!**

# Rotations in 3D

## Rotation about x axis:

$$\mathbf{R}_{x,\theta} = \begin{bmatrix} 1 & 0 & 0 \\ 0 & \cos \theta & -\sin \theta \\ 0 & \sin \theta & \cos \theta \end{bmatrix}$$

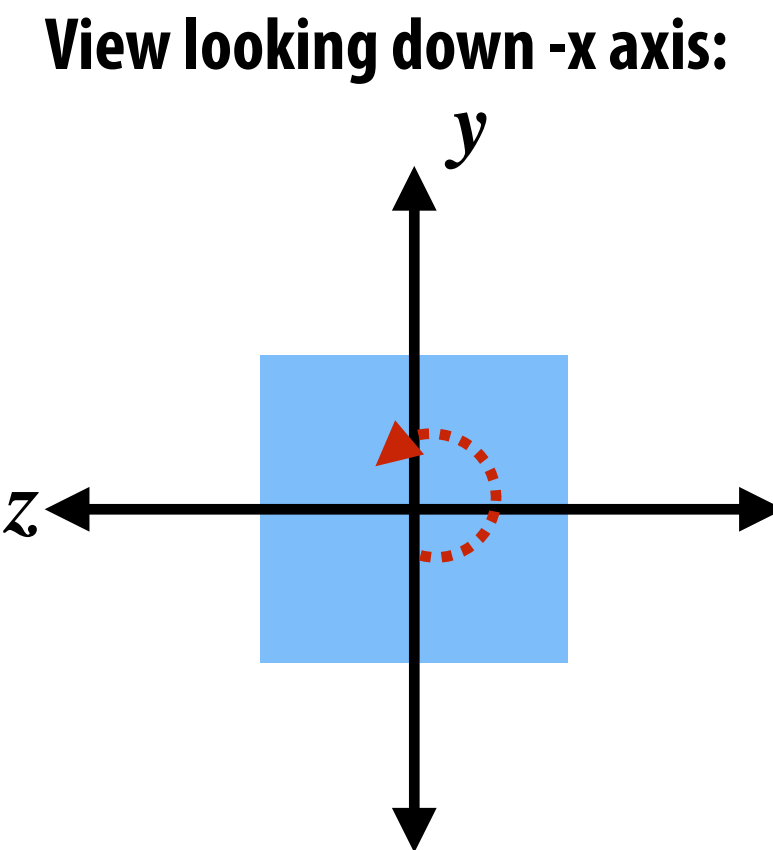
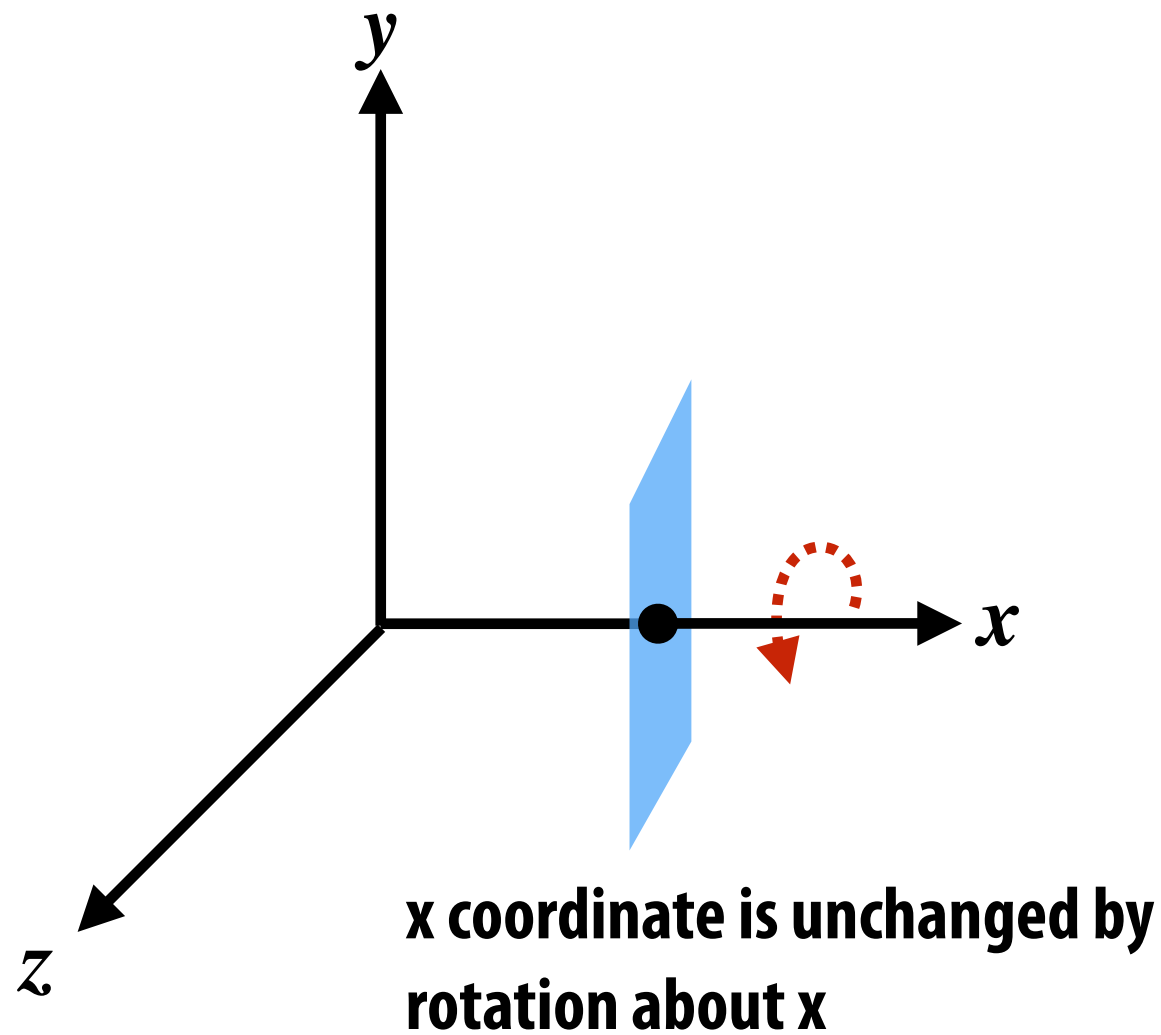

## Rotation about y axis:

$$\mathbf{R}_{y,\theta} = \begin{bmatrix} \cos \theta & 0 & \sin \theta \\ 0 & 1 & 0 \\ -\sin \theta & 0 & \cos \theta \end{bmatrix}$$

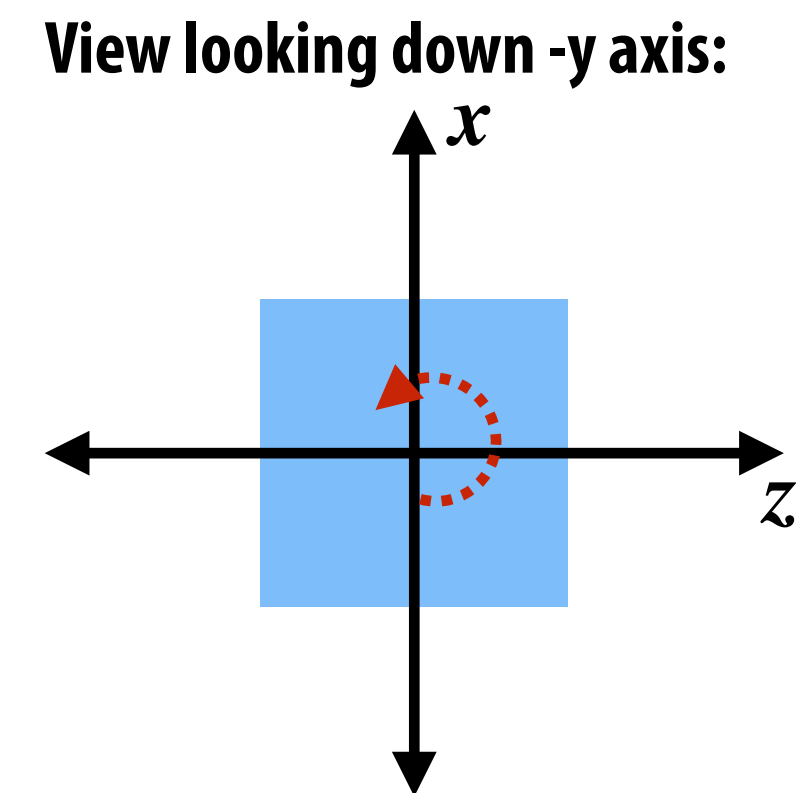

## Rotation about z axis:

$$\mathbf{R}_{z,\theta} = \begin{bmatrix} \cos \theta & -\sin \theta & 0 \\ \sin \theta & \cos \theta & 0 \\ 0 & 0 & 1 \end{bmatrix}$$

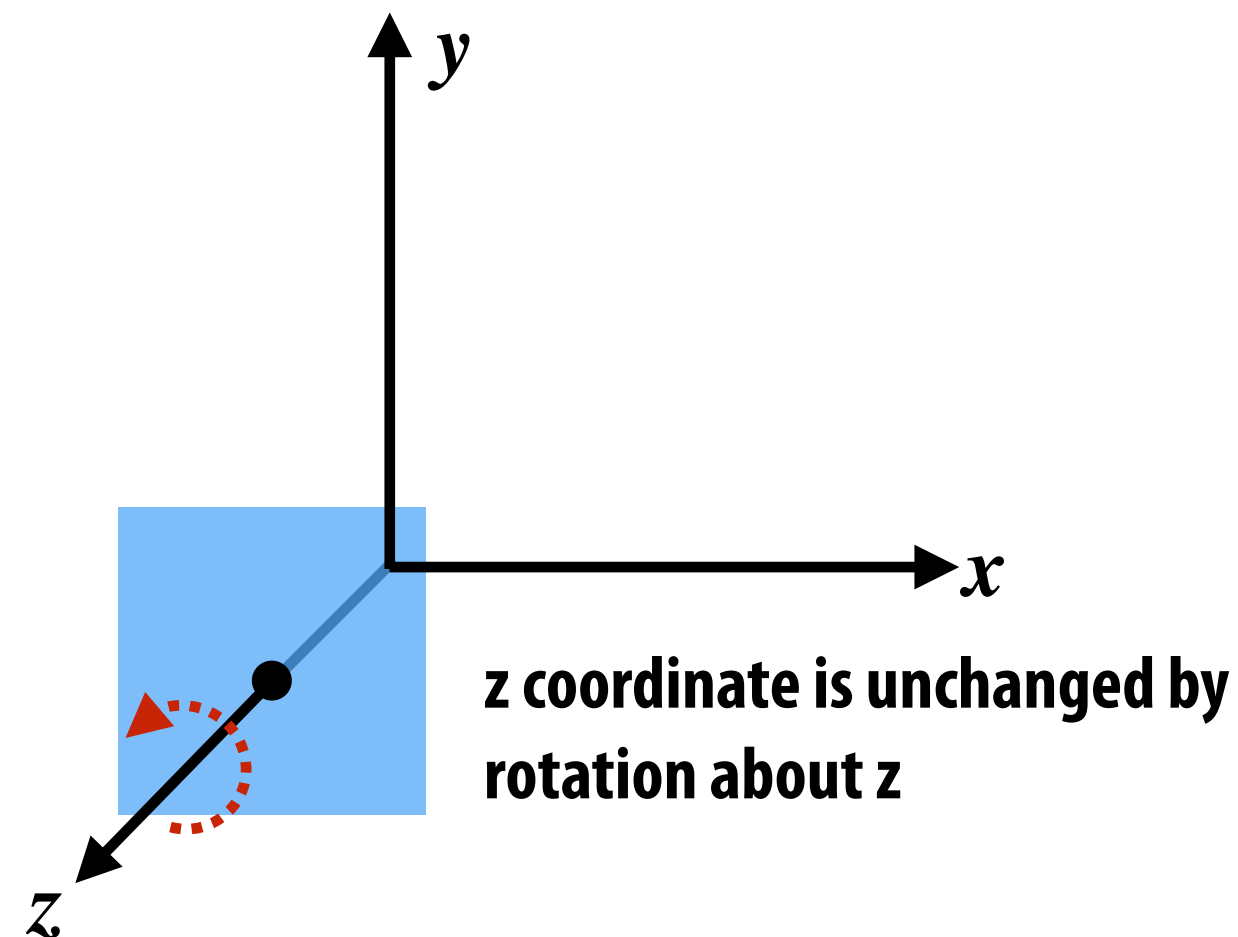

# Representing rotations in 3D—euler angles

- How do we express rotations in 3D?
- One idea: we know how to do 2D rotations
- Why not simply apply rotations around the three axes? (X,Y,Z)
- Scheme is called *Euler angles*
- PROBLEM: “Gimbal Lock” [DEMO]

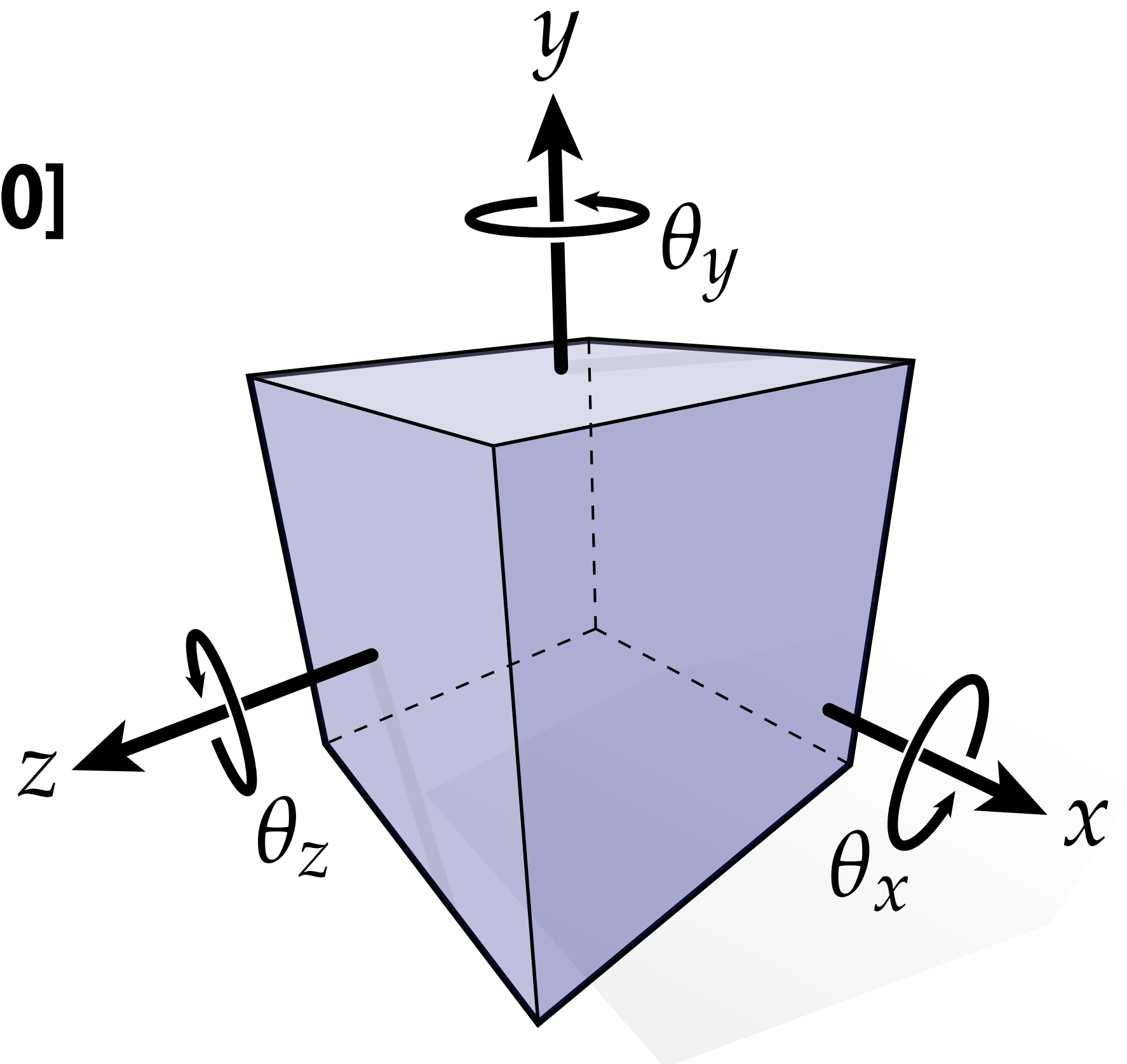
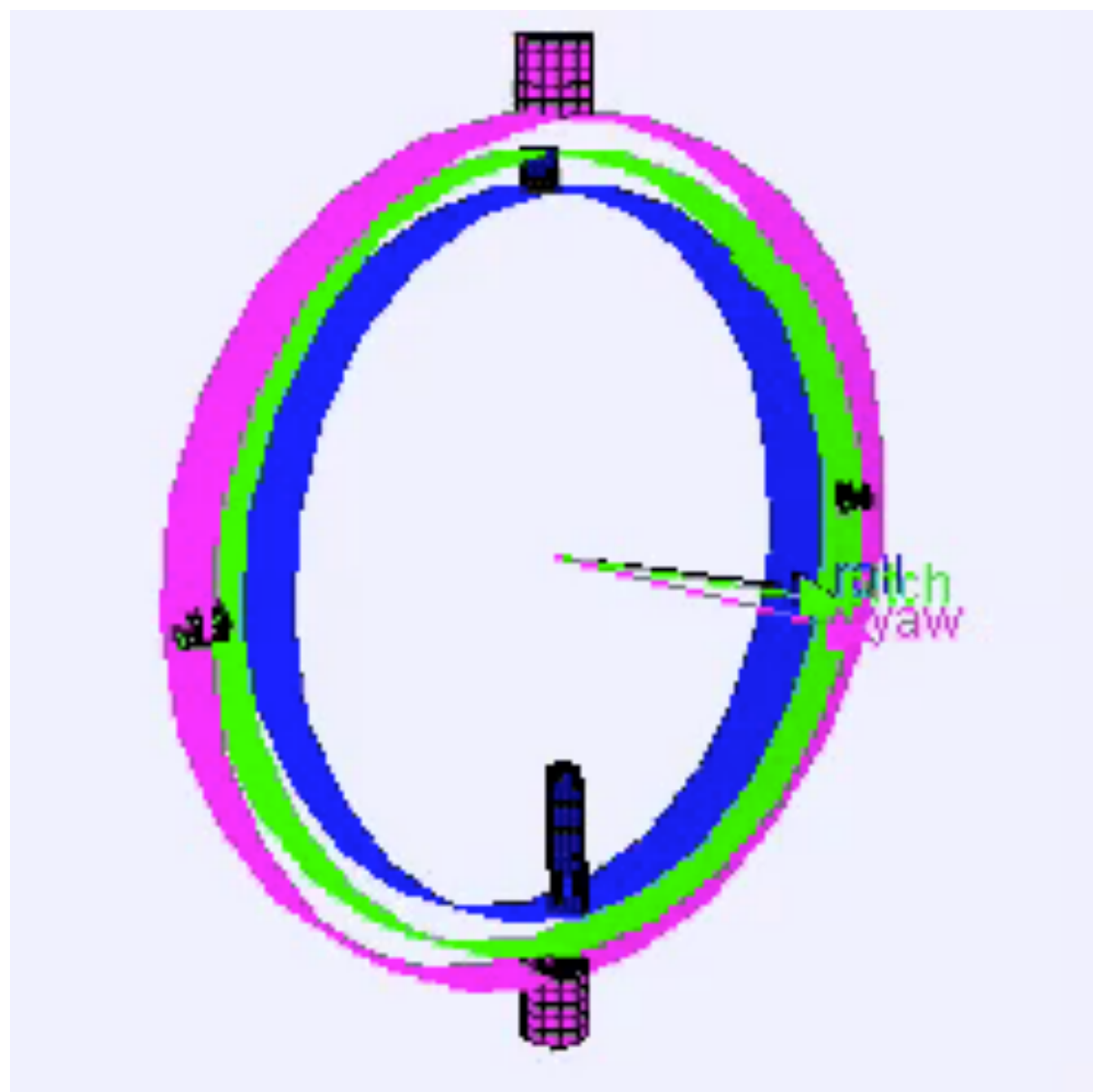

# Alternative representations of 3D rotations

- **Axis-angle rotations**
- **Quaternions (not today)**

# Another way to think about transformations: change of coordinates

Interpretation of transformations so far in this lecture: *points get moved*

Point  $\mathbf{x}$  moved to new position  $f(\mathbf{x})$

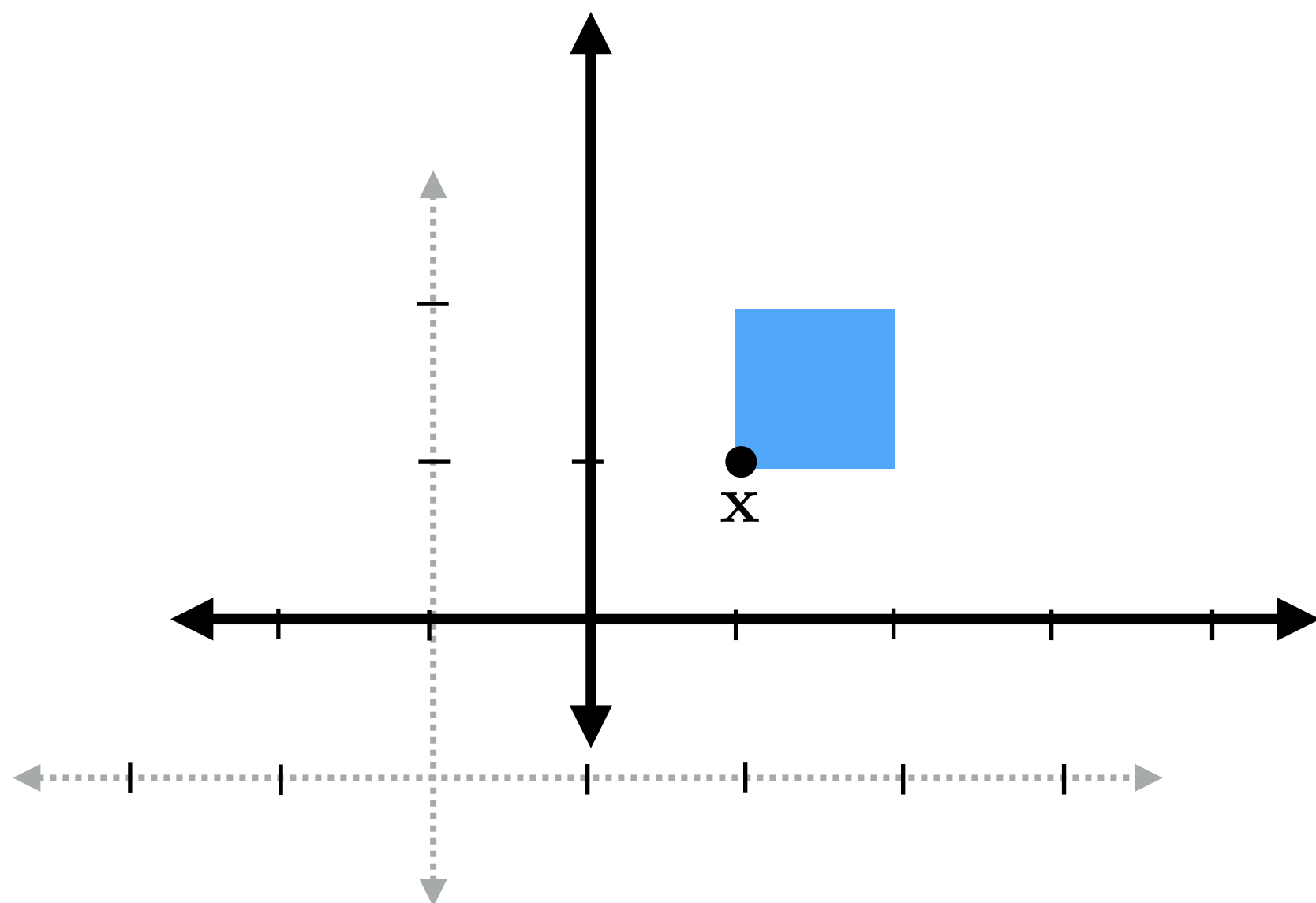
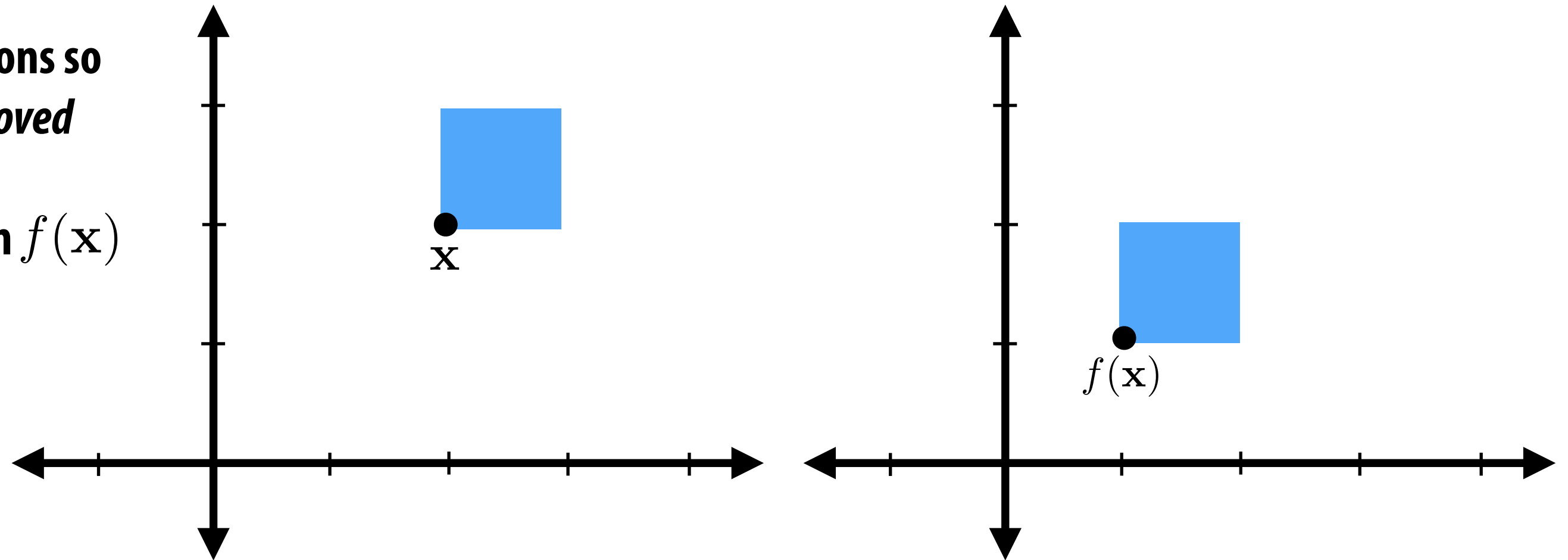

**Alternative interpretation:**

**Transformations induce a change of coordinate frame:  
Representation of  $\mathbf{x}$  changes since point is now  
expressed in new coordinates**

# Screen transformation \*

Convert points in normalized coordinate space to screen pixel coordinates

Example: all points within  $(-1,1)$  to  $(1,1)$  region are on screen

$(1,1)$  in normalized space maps to  $(W,0)$  in screen space

$(-1,-1)$  in normalized space maps to  $(0,H)$  in screen space

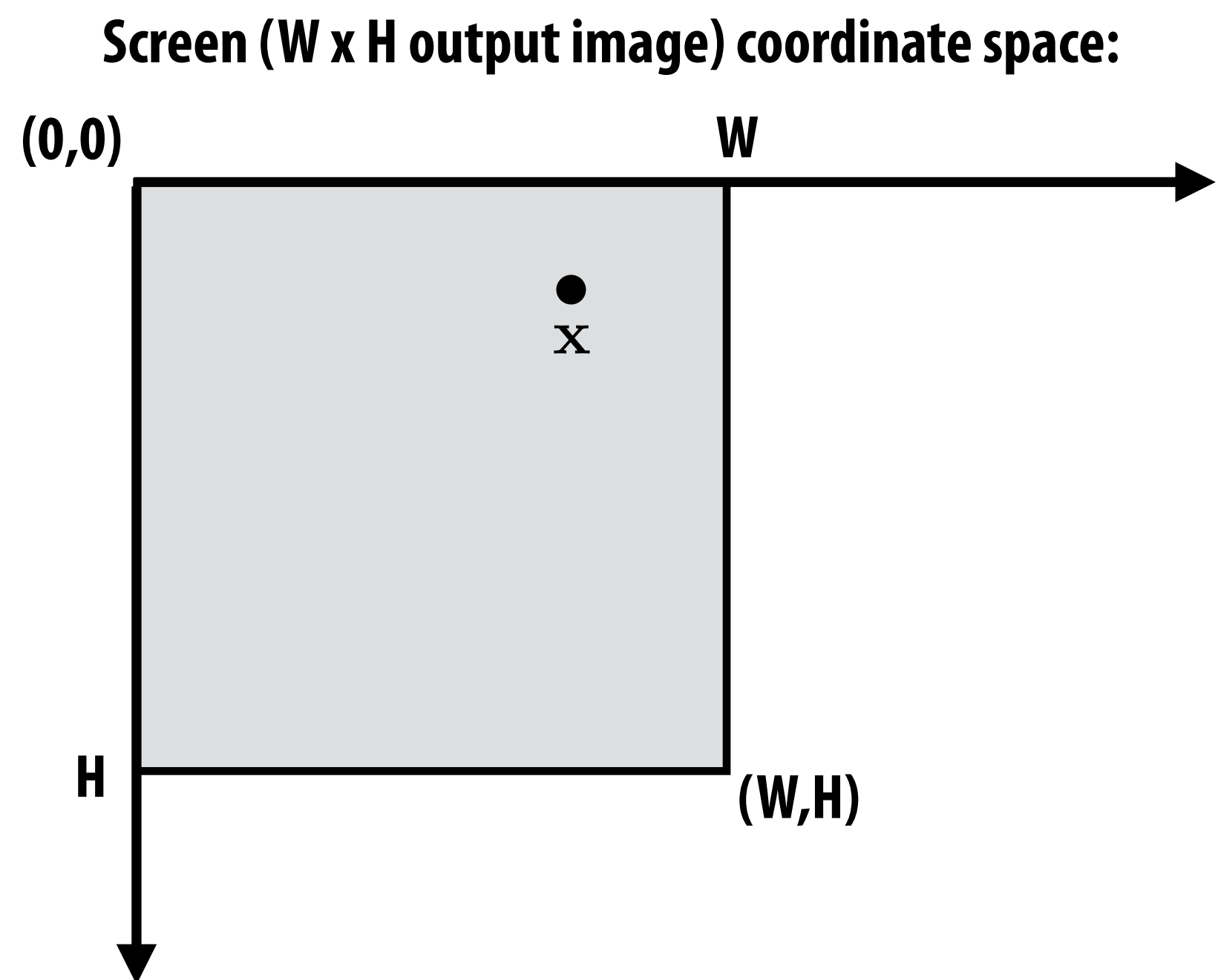
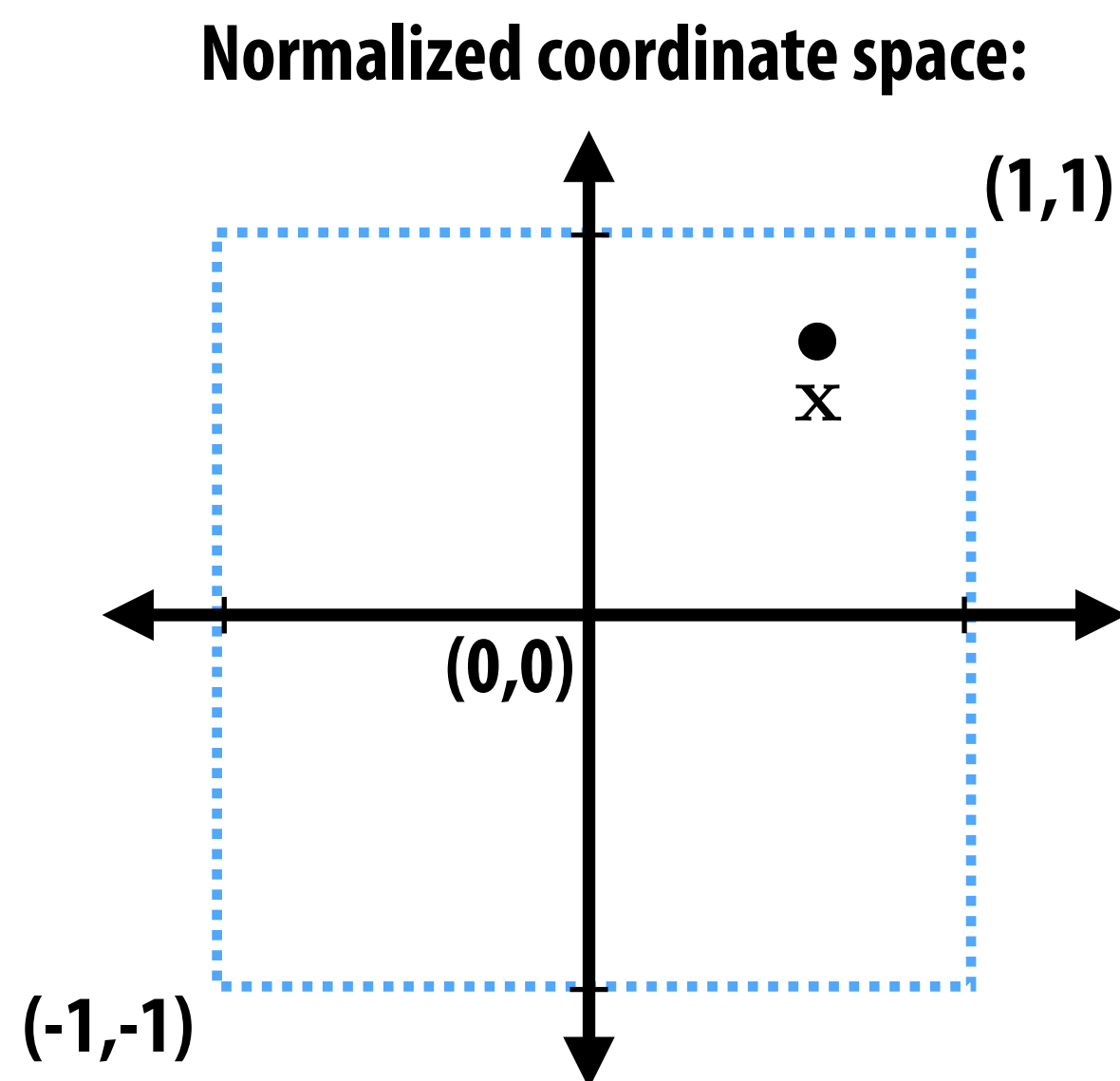

**Step 1: reflect about x**

**Step 2: translate by  $(1,1)$**

**Step 3: scale by  $(W/2, H/2)$**

\* This slide adopts convention that top-left of screen is  $(0,0)$  to match SVG convention in Assignment 1.

Many 3D graphics systems like OpenGL place  $(0,0)$  in bottom-left. In this case what would the transform be?



# Example: simple camera transform

Consider object positioned in world at  $(10, 2, 0)$

Consider camera at  $(4, 2, 0)$ , looking down x axis

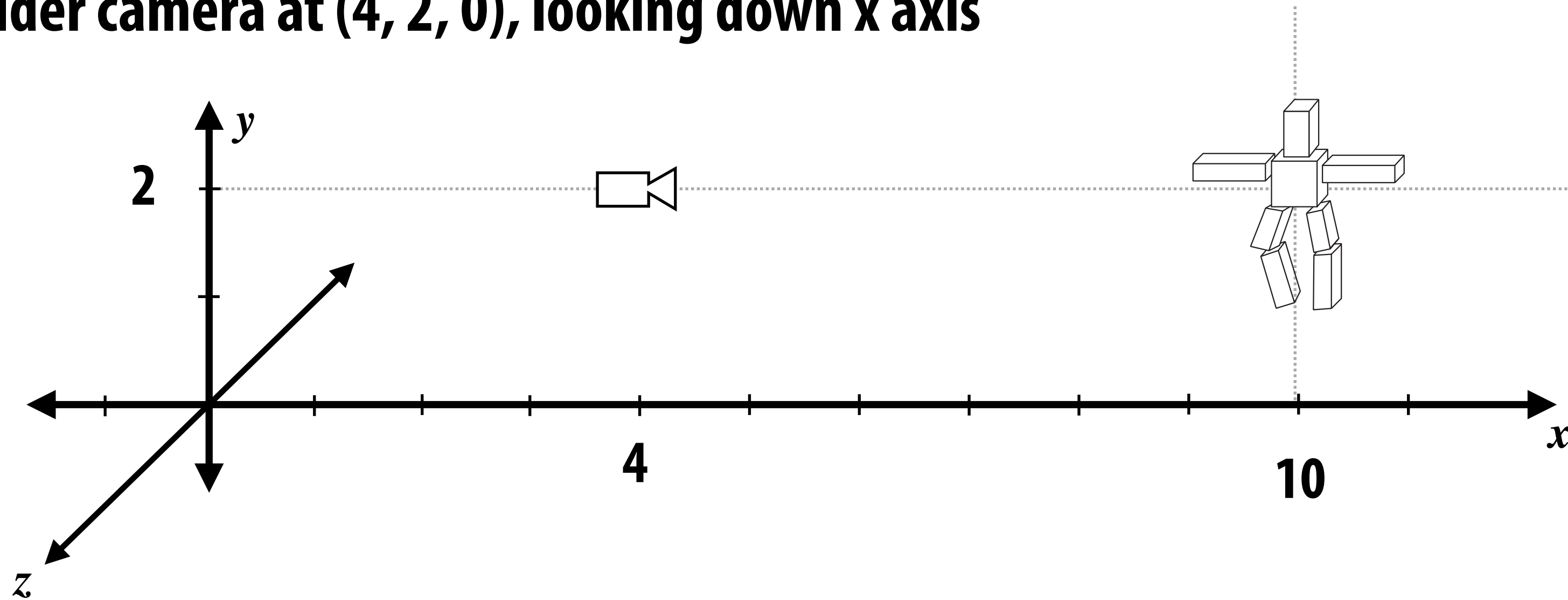

What transform places in the object in a coordinate space where the camera is at the origin and the camera is looking directly down the  $-z$  axis?

- Translating object vertex positions by  $(-4, -2, 0)$  yields position relative to camera
- Rotation about  $y$  by  $\pi/2$  gives position of object in new coordinate system where camera's view direction is aligned with the  $-z$  axis \*

\* The convenience of such a coordinate system will become clear on the next slide!

# Camera looking in a different direction

Consider camera at origin looking in direction  $\mathbf{w}$

What transform places in the object in a coordinate space where the camera is at the origin and the camera is looking directly down the  $-z$  axis?

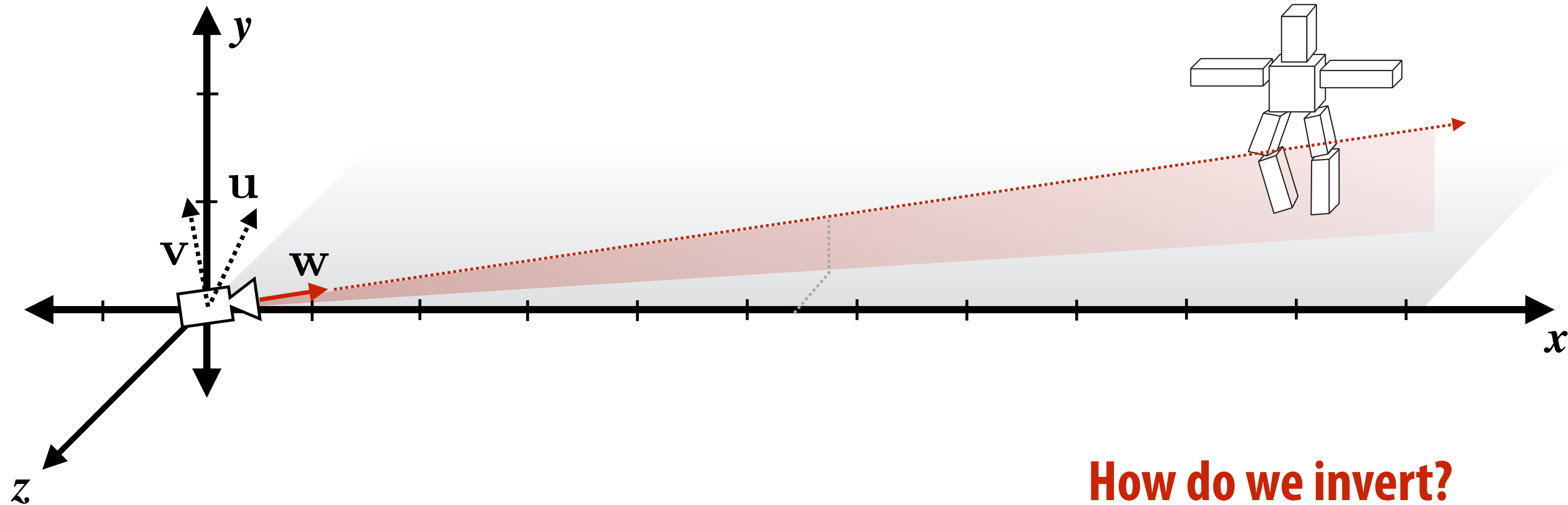

Form orthonormal basis around  $\mathbf{w}$ : (see  $\mathbf{u}$  and  $\mathbf{v}$ )

Consider rotation matrix:  $\mathbf{R}$

$$\mathbf{R} = \begin{bmatrix} \mathbf{u}_x & \mathbf{v}_x & -\mathbf{w}_x \\ \mathbf{u}_y & \mathbf{v}_y & -\mathbf{w}_y \\ \mathbf{u}_z & \mathbf{v}_z & -\mathbf{w}_z \end{bmatrix}$$

$\mathbf{R}$  maps  $x$ -axis to  $\mathbf{u}$ ,  $y$ -axis to  $\mathbf{v}$ ,  $z$  axis to  $-\mathbf{w}$

How do we invert?

$$\mathbf{R}^{-1} = \mathbf{R}^T = \begin{bmatrix} \mathbf{u}_x & \mathbf{u}_y & \mathbf{u}_z \\ \mathbf{v}_x & \mathbf{v}_y & \mathbf{v}_z \\ -\mathbf{w}_x & -\mathbf{w}_y & -\mathbf{w}_z \end{bmatrix}$$

Why is that the inverse?

$$\mathbf{R}^T \mathbf{u} = [\mathbf{u} \cdot \mathbf{u} \quad \mathbf{v} \cdot \mathbf{u} \quad -\mathbf{w} \cdot \mathbf{u}]^T = [1 \quad 0 \quad 0]^T$$

$$\mathbf{R}^T \mathbf{v} = [\mathbf{u} \cdot \mathbf{v} \quad \mathbf{v} \cdot \mathbf{v} \quad -\mathbf{w} \cdot \mathbf{v}]^T = [0 \quad 1 \quad 0]^T$$

$$\mathbf{R}^T \mathbf{w} = [\mathbf{u} \cdot \mathbf{w} \quad \mathbf{v} \cdot \mathbf{w} \quad -\mathbf{w} \cdot \mathbf{w}]^T = [0 \quad 0 \quad -1]^T$$

# Self-check exercise (for home)

- **Given a camera position  $P$**
- **And a camera orientation given by orthonormal basis  $u, v, w$  (camera looking in  $w$ )**
- **What is a transformation matrix that places the scene in a coordinate space where...**
  - **The camera is at the origin**
  - **The camera is looking down  $-z$ .**

# Basic perspective projection

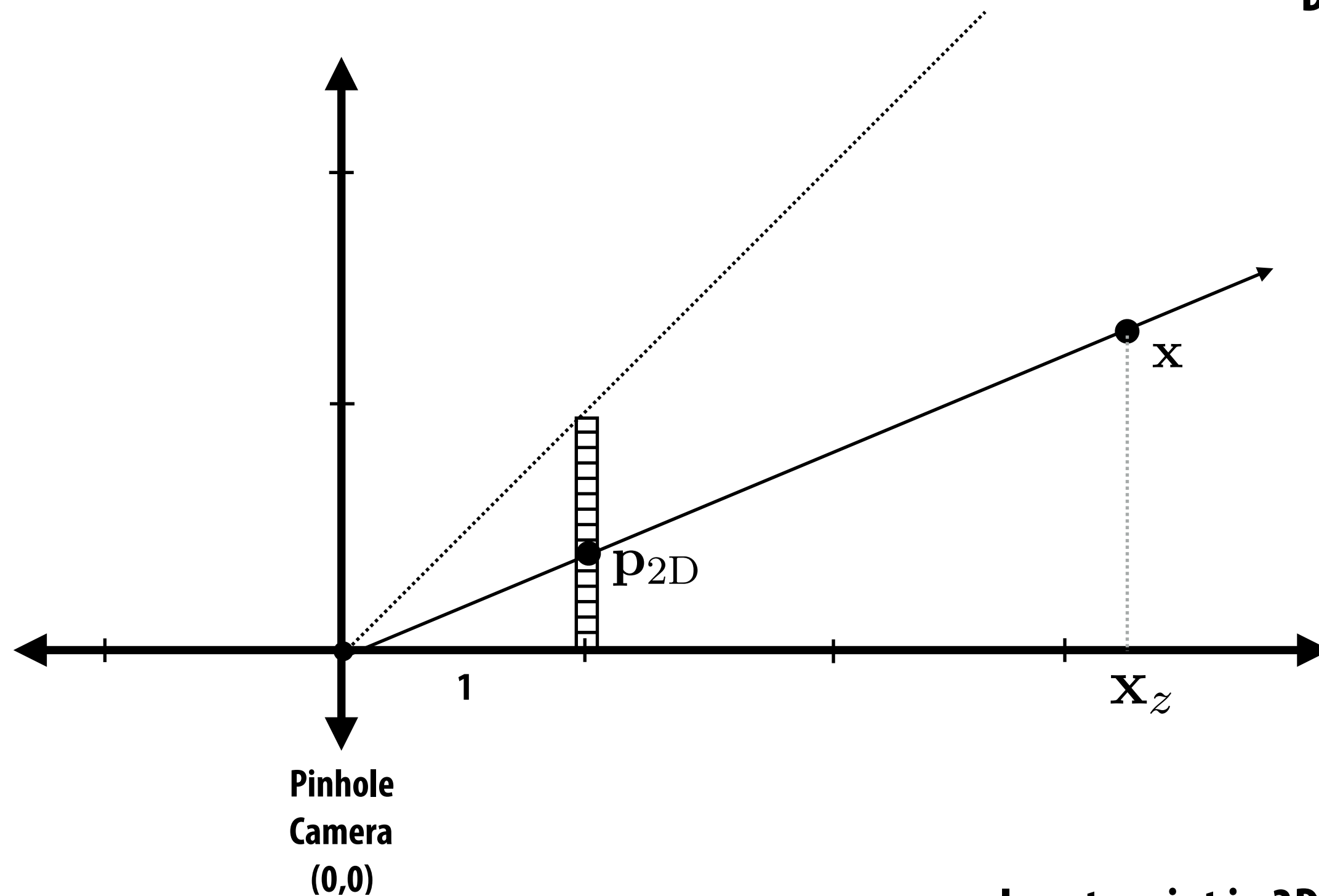

Desired perspective projected result (2D point):

$$\mathbf{p}_{2D} = \left[ \mathbf{x}_x / \mathbf{x}_z \quad \mathbf{x}_y / \mathbf{x}_z \right]^T$$

$$\mathbf{P} = \begin{bmatrix} 1 & 0 & 0 & 0 \\ 0 & 1 & 0 & 0 \\ 0 & 0 & 1 & 0 \\ 0 & 0 & 1 & 0 \end{bmatrix}$$

Input: point in 3D-H

$$\mathbf{x} = \left[ \mathbf{x}_x \quad \mathbf{x}_y \quad \mathbf{x}_z \quad 1 \right]$$

After applying  $\mathbf{P}$ : point in 3D-H

$$\mathbf{P}\mathbf{x} = \left[ \mathbf{x}_x \quad \mathbf{x}_y \quad \mathbf{x}_z \quad \mathbf{x}_z \right]^T$$

After homogeneous divide:

$$\left[ \mathbf{x}_x / \mathbf{x}_z \quad \mathbf{x}_y / \mathbf{x}_z \quad 1 \right]^T$$

(throw out third component to get 2D)

**Assumption:**  
Pinhole camera at (0,0) looking down z

**More about perspective next lecture!**

**Let's make a cube person**

# Skeleton - hierarchical representation

torso

head

right arm

upper arm

lower arm

hand

left arm

upper arm

lower arm

hand

right leg

upper leg

lower leg

foot

left leg

upper leg

lower leg

foot

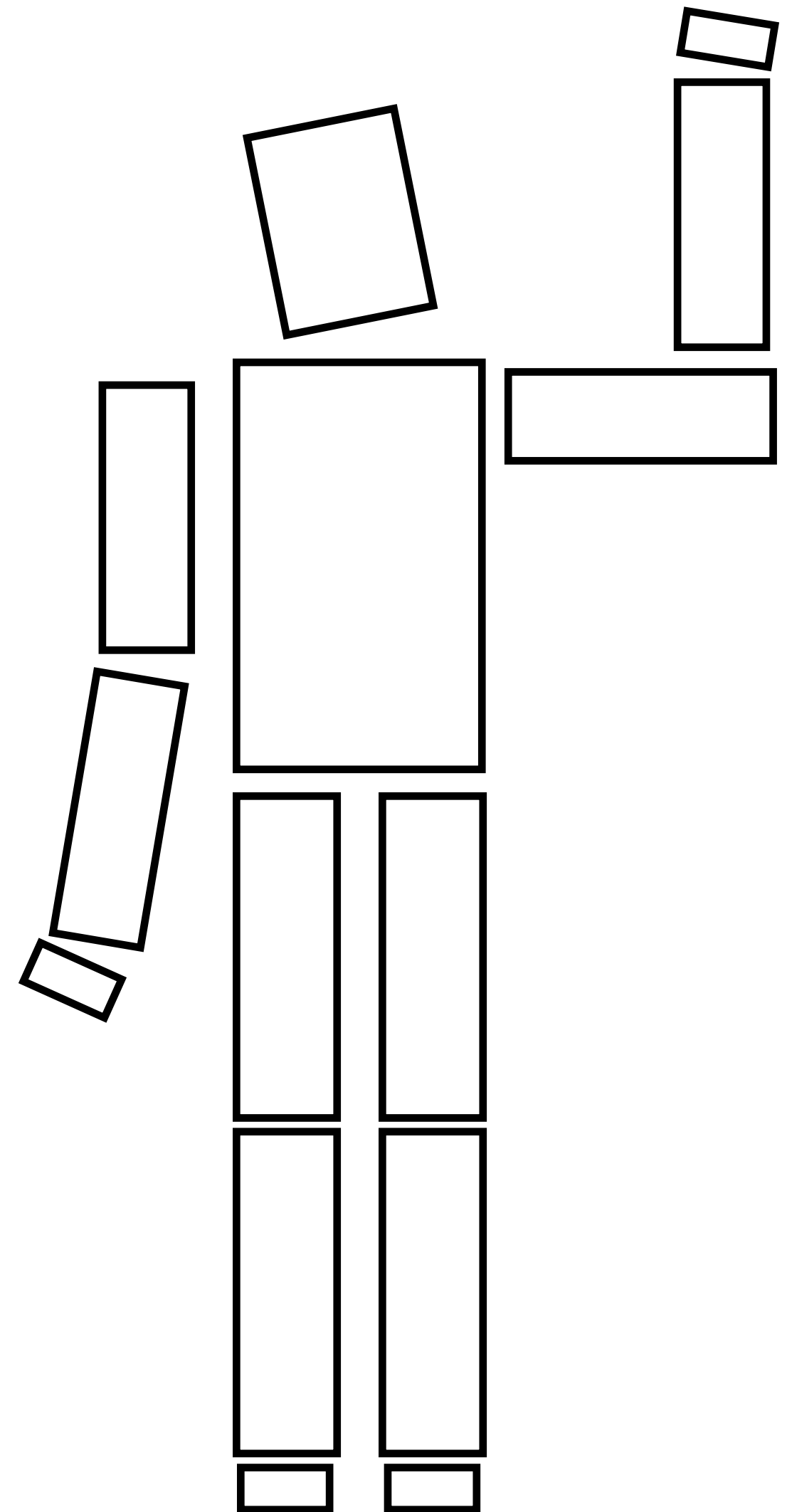



# Hierarchical representation

- **Grouped representation (tree)**
  - **Each group contains subgroups and/or shapes**
  - **Each group is associated with a transform relative to parent group**
  - **Transform on leaf-node shape is concatenation of all transforms on path from root node to leaf**
  - **Changing a group's transform affects all parts**
    - **Allows high level editing by changing only one node**
    - **E.g. raising left arm requires changing only one transform for that group**

# Skeleton - hierarchical representation

```
translate(0, 10);
drawTorso();
pushmatrix(); // push a copy of transform onto stack
  translate(0, 5); // right-multiply onto current transform
  rotate(headRotation); // right-multiply onto current transform
  drawHead();
popmatrix(); // pop current transform off stack
pushmatrix();
  translate(-2, 3);
  rotate(rightShoulderRotation);
  drawUpperArm();
  pushmatrix();
    translate(0, -3);
    rotate(elbowRotation);
    drawLowerArm();
    pushmatrix();
      translate(0, -3);
      rotate(wristRotation);
      drawHand();
    popmatrix();
  popmatrix();
popmatrix();
....
```

right  
hand

right  
lower  
arm  
group

right  
arm  
group

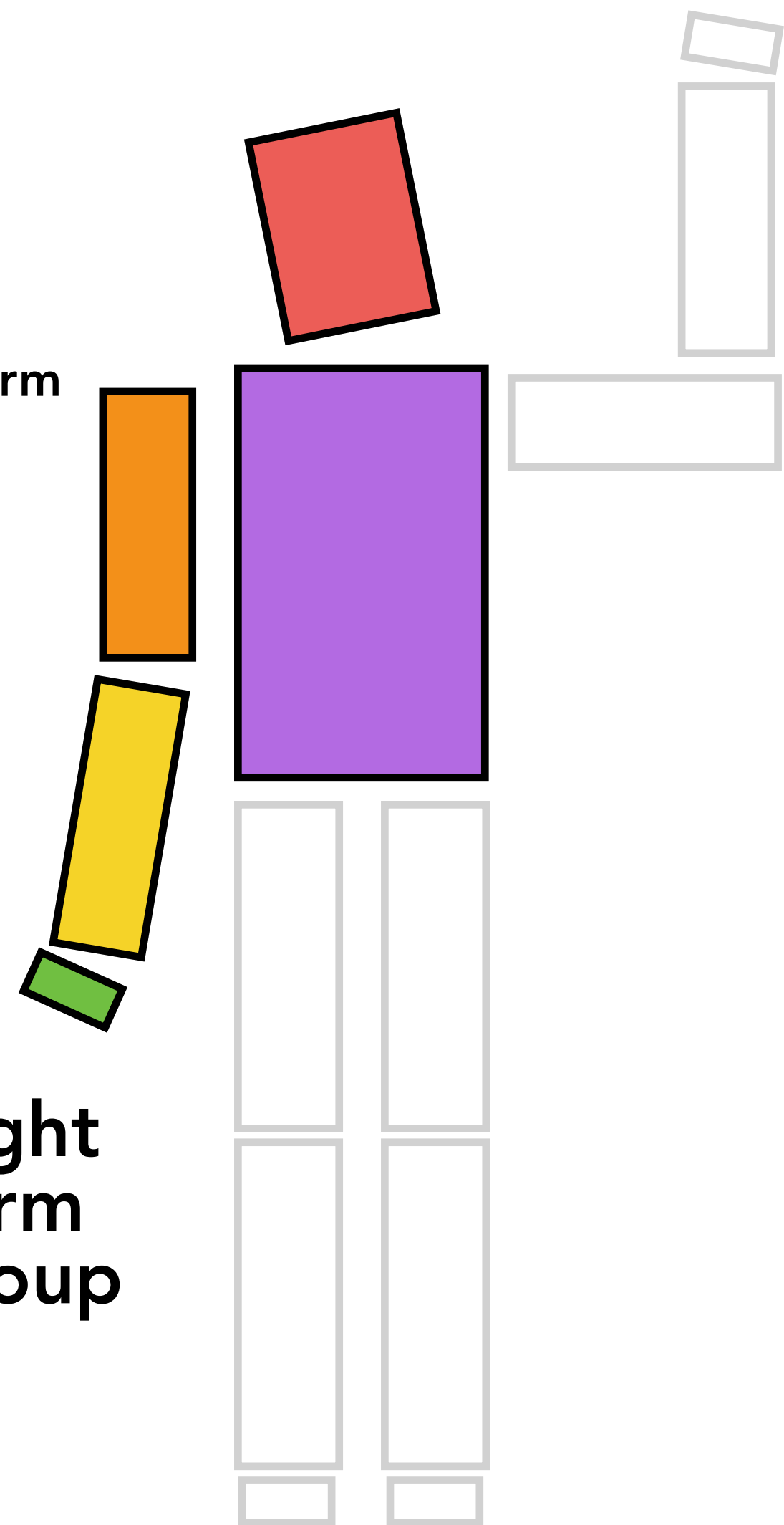

# Skeleton - hierarchical representation

```
translate(0, 10);
drawTorso();
pushmatrix(); // push a copy of transform onto stack
  translate(0, 5); // right-multiply onto current transform
  rotate(headRotation); // right-multiply onto current transform
  drawHead();
popmatrix(); // pop current transform off stack
pushmatrix();
  translate(-2, 3);
  rotate(rightShoulderRotation);
  drawUpperArm();
  pushmatrix();
    translate(0, -3);
    rotate(elbowRotation);
    drawLowerArm();
    pushmatrix();
      translate(0, -3);
      rotate(wristRotation);
      drawHand();
    popmatrix();
  popmatrix();
popmatrix();
....
```



right  
hand

right  
lower  
arm  
group

right  
arm  
group

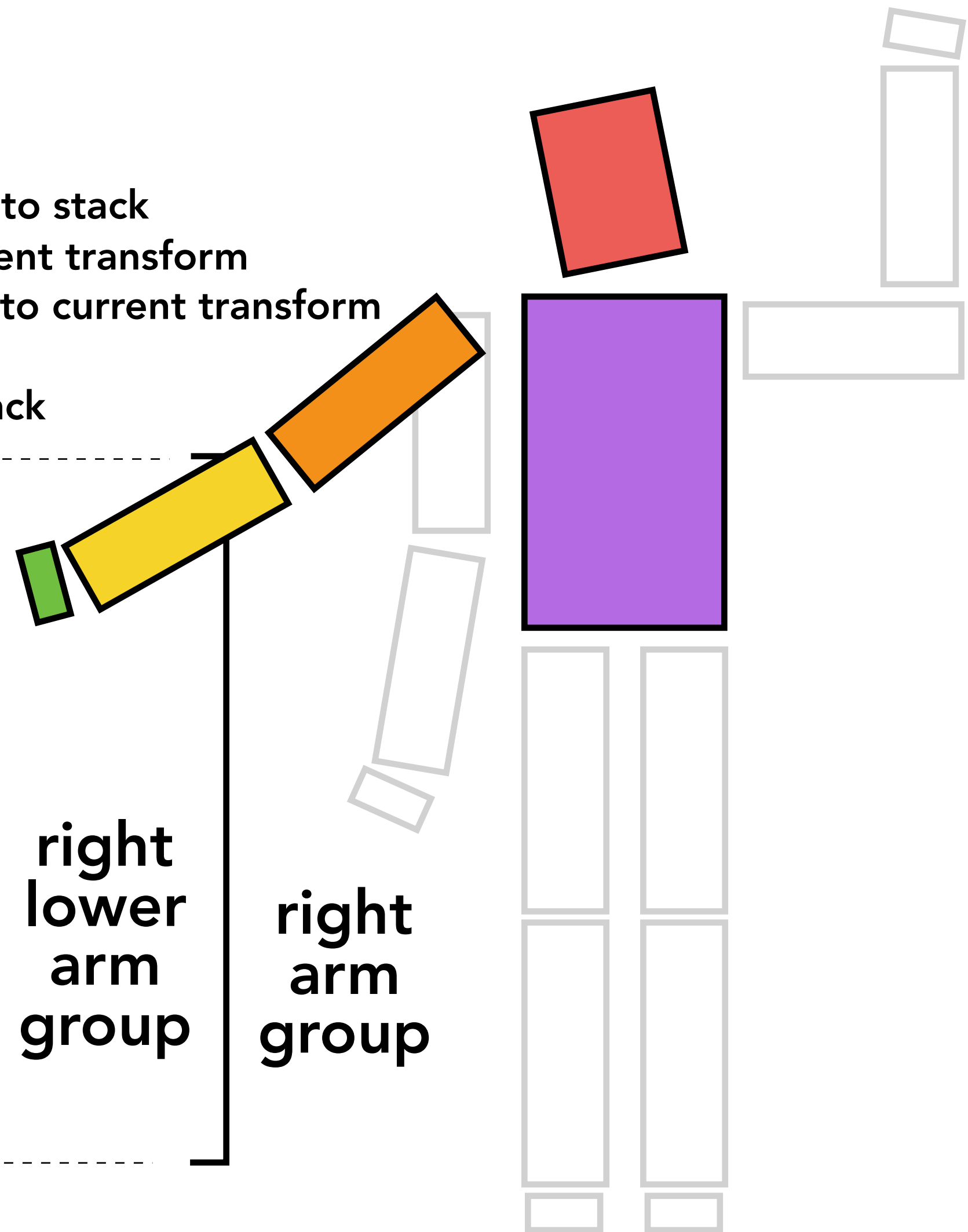

# Transformations summary

- Transformations can be interpreted as operations that move points in space
  - e.g., for modeling, animation
- Or as a change of coordinate system
  - e.g., screen and view transforms
- Construct complex transformations as compositions of basic transforms
- Homogeneous coordinate representation allows for expression of non-linear transforms (e.g., translation, perspective projection) as matrix operations (linear transforms) in higher-dimensional space
  - Matrix representation affords simple implementation and efficient composition

